

## *Self-Actuated* Temperature Regulator RT-1007-AI "Fail-Safe" Series

Prevents Overheating when  
Thermal System is inoperative

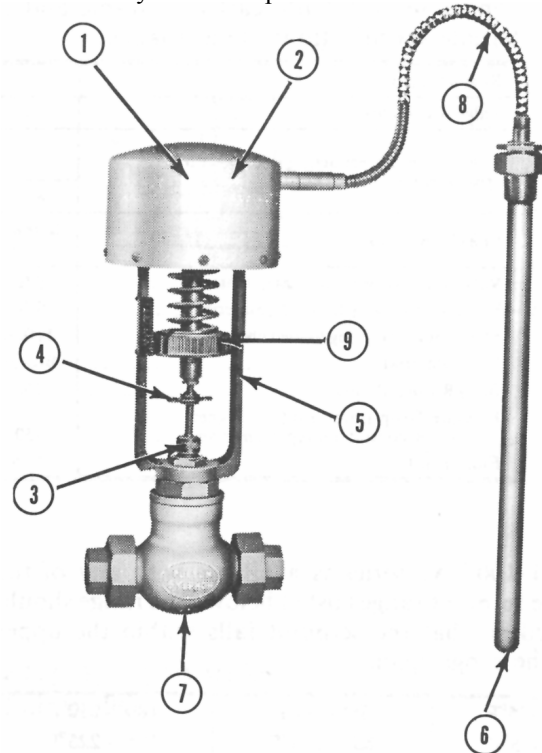

*Cataloged Sizes: Direct-acting, 1 1/4" - 4"  
Reverse-acting, 2 1/2" - 4"*

Most cataloged Robertshaw SATR specifications are starting points from which many alternates to cataloged capillary, sensing bulb, separable well and valve may be FURNISHED TO MEET YOUR SPECIFIC application's needs.

### FEATURES

1. Safety type. Failure due to loss of thermostatic charge automatically moves direct-acting (heating) valve to fully closed position or reverse-acting valve (cooling) valve to fully-open position to prevent overheating.
2. Extra large, two-ply, seamless Robertshaw bellows used for long life and extra power.
3. Chevron "Lifetime" stem packing made of Teflon\* or EPT Rubber U-cup for water service.
4. Quick-detach valve stem construction permits easy valve change.
5. Sturdy construction with cast iron frame.
6. Variety of sensing bulb forms and materials. (See inside pages)
7. Valves in wide range of sizes, actions, styles, materials, etc. for many services. (See inside pages).
8. Capillary selection (See inside pages).
9. Setpoint Adjustment Wheel
10. All components manufactured by a single source.

### GENERAL

Without need for external power, Robertshaw Self-Actuated Temperature Regulators (SATR) offer final control of the temperature of a liquid, an air space or flow, or gas flow for domestic, equipment, process, space, etc. on heating or cooling service.

The SATR sensing bulb is installed in the medium being controlled while the SATR valve is located on the supply line of the medium used as the heating (steam, hot water) or cooling (water, ethylene glycol, brine) agent. The SATR regulates the heating or cooling medium flow to maintain the desired temperature at the sensing bulb location. Robertshaw SATR are usually cataloged to detail the two-way direct acting (close on temperature rise) type valves for heating service. Two-way reverse-acting (open on temperature rise) and three-way valves are equally available for cooling service.

The cataloged Robertshaw SATR series offers a selection of: Throttling bands, Temperature Indication, Fail-safe to prevent overheating, Manual Positioning in addition to automatic control, Corrosive atmosphere resistant type, Small overall size and instantaneous heat exchanger service.

Most cataloged Robertshaw SATR specifications are starting points from which many alternates to cataloged capillary, sensing bulb, separable well and valve may be FURNISHED TO MEET YOUR SPECIFIC application's needs.

### HOW TO ORDER

1. Quantity
2. Size
3. Series number
4. Setpoint and/or setpoint range
5. Capillary specs
6. Sensing bulb specs
7. Valve type, action, ends, etc.
8. Other features
9. Shipping and invoicing instructions

**RT-1007-AI Series**

The RT-1007-AI series is a non-indicating design suited to heating or cooling applications where temperature overheating is of basic concern. This series is designed and constructed to push the stem downward in the event of a loss of thermal charge. It will close a direct-acting valve or open a reverse-acting valve, on charge loss, to prevent the

overheating associated with other temperature regulators.

The RT-1007-AI series can be supplied with small valve sizes; however, the more economical RT-1006-BI is normally used with the advantage of smaller bulb size, etc.

For cataloging and pricing purposes, the RT-1007-AI series is detailed with direct acting valves for heating service, 8 ft. capillary (copper with brass armor), 12 type (threaded bushing) copper sensing bulb, cast iron frame and other non-listed parts of non-ferrous metals. Alternate specifications are available.

Regulator No.	RT-1007-AI					
Valve size, Inches	1 1/4	1 1/2	2	2 1/2	3	4
Valve Type, Direct-acting (closes with rising temperature at bulb)	Single seated Balanced			Double seated Semi-balanced		
	MA	MA	MA	FA	FA	FA
End Connections	Screwed unions			Flanged (125 lb. ANSI)		
Valve Trim (poppet and seats), material	S.S.	S.S.	S.S.	S.S.	S.S.	S.S.
Valve Stem (highly finished), material	S.S.	S.S.	S.S.	S.S.	S.S.	S.S.
Stem Packing (spring loaded chevrons)	Teflon	Teflon	Teflon	Teflon	Teflon	Teflon
Body Material	Bronze	Bronze	Cast iron	Cast iron	Cast iron	Cast iron
Body Rating, Pounds	250	250	125	125	125	125
Pressure Drop Limit, psi (For higher pressures, consult our representative)	250	250	100	45	35	25
Full open Cv	17.6	25.5	47.8	82.5	130.0	226.0

The RT-1007-AI series is available with any of the adjustable setpoint ranges listed below. The range should be selected so that the setpoint falls within the upper third of the range span.

-50° - -25°F	55° - 85°F	180° - 210°F
-35° - - 5°F	85° -115°F	195° - 225°F
-15° - 15°F	105° -135°F	220° - 250°F
10° - 40°F	125° -155°F	220° - 260°F
35° - 65°F	135° -165°F	285° - 325°F
45° - 75°F	160° -190°F	

**ALTERNATES INCLUDE**

**Capillary:**

- Length* ..... 1 ft. to 50 ft. or more
- Materials* .....Copper or 304 stainless steel, plain or with Plastisol sheathing and SS tube with SS armor.

**Sensing Bulbs:**

- Type 12BP* ..... 316 stainless steel
- Type 12B or 12BP* ..... with "dead extension"
- Type 54* .....Copper, externally finned
- (A) Plain
- (J) Bushed
- (K) Flanged
- Type 6* ..... Plain for open vessels Copper or 304 SS plain or with Plastisol sheathing

**Separable Wells (for sensing bulb protection or ease of removal):**

- Materials* ..... Copper, 316 SS
- Type GA or GA* ..... with lagging extension (Mounting thread one size larger than bulb size)
- Type GB* ..... (Mounting thread same size as bulb size)

**Valves:** .....Types A, FA, WA, WD as illustrated.

**VALVE SIZING**

Valve sizing is critical to control and life of regulator. Use Robertshaw's "Flo-Rule" valve sizing slide rule and valve Cv chart, or contact our representative or factory. The application requirement can frequently be satisfied by one or two sizes smaller valve than the supply pipeline size.

NOTE 1 - **IMPORTANT** - If valve seat leakage can cause a problem or a hazard, the following should be taken into account. Maximum leakage of new valves: single-seated (types A, WA, WD) - 0.05% of full open valve capacity; single-seated balanced (types MA or MAS) - 0.01 %; double-seated (types FA, etc.) -0.5%. This leakage will usually increase somewhat as the valve seats wear in service.

**DIMENSIONS, SHIPPING WEIGHTS  
AND SENSING BULB SIZES**

Regulator No.	RT-1007-AI					
Valve Size, Inches	1 1/4	1 1/2	2	2 1/2	3	4
Direct-Acting Valve, Type	MA	MA	MA	FA	FA	FA
Shipping Wt., Lbs.	37	43	48	100	130	160
A	15-13/16	16-5/16	17-1/8	16-15/16	16-15/16	18
B	12-3/16	12-3/16	12-3/16	12-3/16	12-3/16	12-3/16
D	3-5/8	4-1/8	4-15/16	4-3/4	4-3/4	5-13/16
E	7-1/2	8-1/2	7	7-3/4	8-5/8	10-1/4
<b>Standard bulb for temperature ranges beginning at 120° F. or above</b>						
G	1 1/4	1 1/4	1 1/4	1 1/4	1 1/4	1 1/4
H	18	18	24	18	18	24
T*	1 1/4	1 1/4	1 1/4	1 1/4	1 1/4	1 1/4
<b>**Standard bulb for temperature ranges beginning below 120° F.</b>						
G	1 1/2	1 1/2	1 1/2	1 1/2	1 1/2	1 1/2
H	28	28	32	28	28	32
T*	1 1/2	1 1/2	1 1/2	1 1/2	1 1/2	1 1/2

8 FT CATALOGED

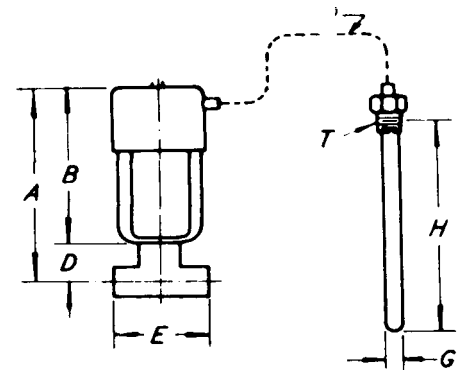

- \* Standard pipe thread.
- \*\* Bulb sizes for ranges beginning below 120° F. are necessary to provide "Crossambient" charge. This assures operation with ambient temperatures either above or below the control setting. Under some conditions smaller bulbs may be used with lower ranges. If the larger bulb cannot be used, consult the factory or nearest representative.

**SATR VALVES FOR RT-1007-AI SERIES**  
(See Valve spec sheets for full details)

TWO WAY

THREE WAY

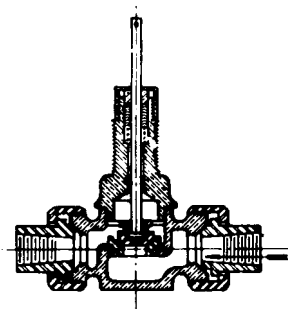

Style A, Union Fads.  
Single Seated  
Unbalanced  
Direct 8c Rev. Acting  
Sizes 1/4" - 1 1/2"  
Bronze  
SS Trim

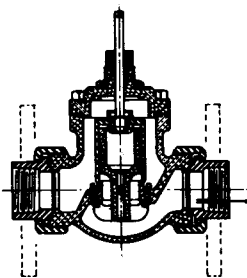

Style MA  
Single Seated  
Fully Balanced  
Direct Acting only  
Sizes 3/4" - 1 1/2" Bronze  
or Steel, 2" Bronze, Cast  
Iron or Steel  
SS Trim

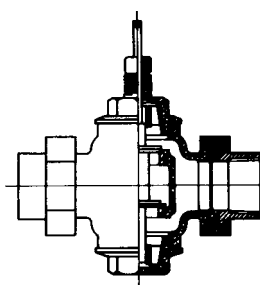

Style FA  
Double Seated  
Semi-Balanced  
Rev. Acting:  
3/4" - 1 1/2"  
Bz body; Bz unions;  
Trim Bz or Monel  
2" - 4"  
Cl or Bz body; Flgd;  
Trim Bz, SS or Monel  
Dir. Acting:  
2 1/2" - 4"  
Cl or Bz body; Flgd;  
Trim Bz or SS

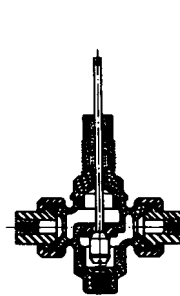

Style WA, Union Ends  
Unbalanced sizes 1/2" - 1  
1/2" Bronze Body SS  
Trim

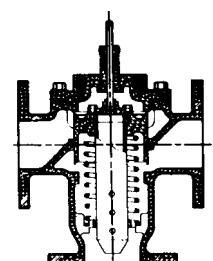

Style WD  
Balanced  
Sizes 2" - 2 1/2"  
Bronze Body, Flgd  
Bronze Trim

## *Robertshaw*

### **U.S.A. and CANADA**

Robertshaw Industrial Products Division  
1602 Mustang Drive  
Maryville, TN 37801  
Phone: (865) 981-3100 Fax: (865) 981-3168  
<http://www.robertshawindustrial.com>

### **Exports**

Invensys Appliance Controls  
2809 Emerywood Parkway  
P.O. Box 26544  
Richmond, Virginia 23261-6544  
Phone: (804) 756-6500 Fax: (804) 756-6561