

DIGITAL METER



NOVA PD560 Series

Instruction Manual

PD562 / 568

PRECISION DIGITAL CORPORATION

19 Strathmore Road • Natick MA 01760 USA
Tel (800) 343-1001 • Fax (508) 655-8990



Disclaimer

The information contained in this document is subject to change without notice. Precision Digital Corporation makes no representations or warranties with respect to the contents hereof, and specifically disclaims any implied warranties of merchantability or fitness for a particular purpose.

Registered Trademarks

MODBUS® is a registered trademark of Schneider Automation Inc. All other trademarks mentioned in this document are the property of their respective owners.

©2004 Precision Digital Corporation. All rights reserved.

Visit our Web Site
<http://www.predig.com>

Table of Contents

1. Safety Guide and Specifications	5
1.1 Specifications	7
2. Front Panel Buttons and LED Indicators	10
3. Parameter Map	11
4. Operation Flow Chart	12
5. Parameter Setup	13
5.1 Input Group (G.IN)	13
5.2 Control Group (G.CTL)	17
5.3 Alarm Group (G.ALM)	19
5.4 Retransmission Group (G.RET)	22
5.5 Communication Group (G.COM)	23
6. Error Display and Correction	25
7. Installation	26
7.1 Dimensions and Panel Cutouts	26
7.2 Panel Mounting	28
7.3 Power Cable Specifications	29
7.4 Terminal Specifications	29
7.5 Terminal Assignment, Connections, and Ratings	30

7.6 Grounding and Power Cable Connection	32
7.7 Signal Input Connection	32
7.8 Retransmission Output Connection (RET)	33
7.9 Relay Output Connection (RELAY)	33
7.10 Digital Input Connection (DI)	34
7.11 Use of an External Relay	34
7.12 Communication Wiring (RS-485)	35

Appendix

Table of D-Registers	36
----------------------------	----

Tables and Figures

Table 1: Universal Input Selection	13
Table 2: DI Operation	17
Table 3: Alarm Selection	20
Fig 1: Temperature Bias	15
Fig 2: Bias Formula Calculation	15
Fig 3: Alarm Operation	20

1. Safety Guide and Specifications



The following safety symbols are used in this manual

- (1) This symbol notifies the user of specific information relating to the safe operation of the controller. Information noted with this symbol must be observed to protect the user from injury and to prevent damage to the product.
 - (A) For User: Be aware of this marking in the manual and refer to the explanation in the manual to prevent injury and damage.
 - (2) For Installer: Study the warnings marked to prevent injury and damage.



- (2) Functional earth terminal: This symbol indicates that the terminal must be connected to ground.



- (3) This symbol indicates additional information on the features of the product.



- (4) This symbol directs the reader to further information on the current topic.



Precautions Regarding This Instruction Manual

- (1) This manual must be kept in the possession of the end user and in a suitable place for the operator to study and to check the functions of the product.
- (2) The installer and operator should carefully study and understand how to operate this product before use.
- (3) This manual describes the functions of the product. Precision Digital Corporation does not guarantee that the functions will suit a particular purpose.
- (4) The contents of this manual have been reviewed for accuracy and correctness. However, should any errors or omissions come to the attention of the user, contact technical support as listed on the back of this manual.



Safety Procedures and Unauthorized Modification Warning

- (1) In order to protect this product and the system controlled by it against damage and ensure its safe use, make certain that all of the safety instructions and precautions in this manual are strictly adhered to.
- (2) Precision Digital Corporation does not guarantee safety if the products are not handled in accordance with this instruction manual.
- (3) If separate protection or safety circuits are to be installed in the system which is controlled by this product, ensure that such circuits are installed external to this product.
- (4) Do not make modifications or additions internally to the product. It may cause personal injury to the user or damage to the product.
- (5) Contact technical support as listed on the back of the manual for warranty and repair issues.
- (6) Exposure to excessive moisture, electrical overloads, or mechanical vibration may damage the product.



Limited Liability

Precision Digital Corporation assumes no liability to any party for any loss or damage, direct or indirect, caused by the use of or any unpredictable defect of the product.



Operational Environment Precautions

- (1) Only operate the controller when it is properly installed.
- (2) When installing the controller, select a location where:
 - Rear terminals are protected from accidental contact.
 - Mechanical vibrations are minimal.
 - No corrosive gas is present.
 - Temperature fluctuation is minimal.
 - Temperature can be maintained between 10 and 50 °C (50 and 110°F) with 20 to 90% RH.
 - No direct heat radiation is present.
 - High levels of electromagnetic interference are not present
 - The unit is not exposed to water.
 - No flammable materials are present.
 - Dust particles are not present in the air.
 - Exposure to ultraviolet rays is minimal.
 - Openings on the rear of the controller are not blocked.
- (3) This unit is suitable for installation in an environment classified as Pollution Degree 2.
- (4) This unit is designated as Installation Category II.
- (5) If the equipment is used in a manner not specified by the manufacturer, the protection provided by the equipment may be impaired.
- (6) A switch or circuit-breaker acting as the disconnect device shall be included in the application or the installation.



Controller Mounting Precautions

- Keep the input circuit wiring as far as possible away from power and ground circuits.
- Keep the units in 10 to 50°C (50 to 110°F) with 20% to 90% relative humidity (RH).

The controller may need a warm up period to return to operating temperature ranges when below 10°C.
- To prevent electric shock, be sure to turn off the power source and circuit breaker before wiring.
- The power requirements are 100 to 240 VAC, 50/60 Hz, 10 VA max. Do not switch power supplies without first disconnecting the power supply.
- Follow the operating procedures and precautions in the manual to avoid fire, shock, damage to the unit, or injury. Follow the operations and mounting directions indicated in this manual.
- Always create a ground connection where indicated, however do not ground to gas pipes, water pipes, lightning rods, or other potentially hazardous metal objects.
- Do not apply power to the unit until all connections have been made.
- Do not cover the venting holes in the rear of the unit.

1.1 SPECIFICATIONS

Except where noted all specifications apply to operation at 23°C.

General

DISPLAY	Two four digit red LED displays (-1999 to 9999) 1/8 DIN PV 19.8 mm (0.78 in), SP 11.5 mm (0.45 in) 1/4 DIN PV 20.5 mm (0.81 in), SP 11.0 mm (0.43 in)
SAMPLING TIME	250 ms
OVERRANGE	Relays trip and PV display reads 9999
PROGRAMMING METHODS	Four front panel buttons, digital inputs, PC software
NOISE FILTER	Programmable from 1 to 120.
RECALIBRATION	All ranges are calibrated at the factory. Recalibration is not required.
MAX/MIN DISPLAY	Max/min readings reached by the process are stored until reset by the user or until power to the meter is turned off.
PASSWORD	Programmable password restricts modification of programmed settings.
POWER	100-240 VAC, 50/60 HZ, 10 Watts
FUSE	Required fuse: UL Recognized, 5 A max, slow blow Up to six units may share one 5 A fuse
ISOLATION	1.5 kV input/output-to-power line 500 V input-to-output
ENVIRONMENTAL	Operating temperature range: 10°C to 50°C (50°F to 110°F) Relative humidity: 20 to 90% non-condensing
MOUNTING	1/8 or 1/4 DIN size cutout required Two panel mounting bracket assemblies provided
WARRANTY	Three years parts and labor
EXTENDED WARRANTY	Extended parts and labor warranties are available at time of ordering

Process and Temperature Inputs

TEMPERATURE DRIFT	Refer to accuracy specifications below
DECIMAL POINT	Up to three decimal places for process inputs: 9.999, 99.99, 999.9, or 9999
REAR JUNCTION COMPENSATION	Automatic or off settings for temperature inputs. No user calibration required.
OFFSET ADJUSTMENT	Four programmable input bias points, each with a programmable offset value.
SENSOR BREAK DETECTION	Open sensor indicated by PV display flashing S.OPN All PID control outputs transmit at the user programmed percent of full output scale set in parameters Po.

UNIVERSAL INPUT TYPE AND ACCURACY

		Temp Range (°C)	Temp Range (°F)	Accuracy*	
Input Type	Thermocouple	K1	-200 to 1370	Temp Ranges > 0°C : ±0.1% ±1 digit Temp Ranges < 0°C : ±0.2% ±1 digit	
		K2	-199.9 to 999.9		
		J	-199.9 to 999.9		
		T	-199.9 to 400.0		
		B	0 to 1800	32 to 3300	Temp Ranges > 400°C : ±0.15% ±1 digit Temp Ranges < 400°C : ±5% ±1 digit
		R	0 to 1700	32 to 3100	All Temp Ranges ±0.15% ±1 digit
		S	0 to 1700	32 to 3100	
		E	-199.9 to 999.9	-300 to 1800	Temp Ranges > 0°C : ±0.1% ±1 digit Temp Ranges < 0°C : ±0.2% ±1 digit
		L	-199.9 to 900.0	-300 to 1600	
		U	-199.9 to 400.0	-300 to 750	
N	-200 to 1300	-300 to 2400	Temp Ranges > 0°C : ±0.1% ±1 digit Temp Ranges < 0°C : ±0.25% ±1 digit		
W	0 to 2300	32 to 4200	All Temp Ranges ±0.2% ±1 digit		
Platinel II	0 to 1390	32 to 2500	All Temp Ranges ±0.1% ±1 digit		
RTD	PIA	-199.9 to 850.0	-300 to 1560	**All Temp Ranges ±0.1% ±1 digit	
	PIB	-199.9 to 500.0	-199.9 to 999.9		
	PIIC	-19.99 to 99.99	-4.0 to 212.0	All Temp Ranges ±0.2% ±1 digit	
	JPIA	-199.9 to 500.0	-199.9 to 999.9	**All Temp Ranges ±0.1% ±1 digit	
JPIB	-150.0 to 150.0	-199.9 to 300.0			
DC Voltage	0.4 to 2.0 V	0.400 to 2.000	All Voltage Ranges ±0.1% ±1 digit Display range can be scaled between -1999 and 9999. To accept a 4-20 mA signal, select 0.4 to 2.0 VDC input and connect a 100 resistor across the input terminals.		
	1 to 5 V	1.000 to 5.000			
	0 to 10 V	0.00 to 10.00			
	-10 to 20 mV	-10.00 to 20.00			
	0 to 100 mV	0.0 to 100.0			

*Performance within recommended operating conditions (10 to 50°C, 20 to 90% RH)

**For a range scale of 0 to 100°C: +0.3°C +1 digit, and for a range scale of -100 to 100°C: +0.5°C +1 digit

Relay Outputs

RATINGS	Alarm1: 250 VAC @ 3 A or 30 VDC @ 3 A (resistive load) Alarm2, 3: 250 VAC @ 1 A or 30 VDC @ 1 A (resistive load)
ELECTRICAL NOISE SUPPRESSION	A suppressor (snubber) should be connected to each relay contact switching inductive loads, to prevent disruption to the microprocessor's operation. Recommended suppressor value: 0.1 μ F/470 Ω , 250 VAC (PDX6901)
DEADBAND	For alarm operations, 0-100% of full scale, user selectable
HIGH OR LOW ALARM	User may program each relay for high or low trip point.
TIME DELAY	0 to 99 minutes 59 seconds alarm trip delay for each alarm.
FAIL-SAFE OPERATION	Programmable, standby option independent for each alarm
AUTO INITIALIZATION	When power is applied to the meter, alarm relays will reflect the state of the input to the meter except standby alarms.

Retransmitting Output

OUTPUT RANGE	Retransmitting: 4 to 20 mA (600 Ω maximum)
SCALING RANGE	Any display range (see range for the input selected)
ACCURACY	\pm 0.1% of full scale

Serial Communications

PROTOCOLS	Modbus (ASCII, RTU), PC software,
UNIT ADDRESS	1 to 99 (Max 31 units connected)
BAUD RATE	600, 1200, 2400, 4800, 9600, 19200 bps, user selectable
RESPONSE TIME	0 to 100 ms delay response time 10 ms increments user selectable
DATA	7 or 8 bit user selectable
PARITY	None, even, or odd

Approvals

UL RECOGNIZED	USA and Canada UL 3121-1, Process Control Equipment
UL FILE NUMBER	E244207
CE COMPLIANT	

2. Front Panel Buttons and LED Indicators

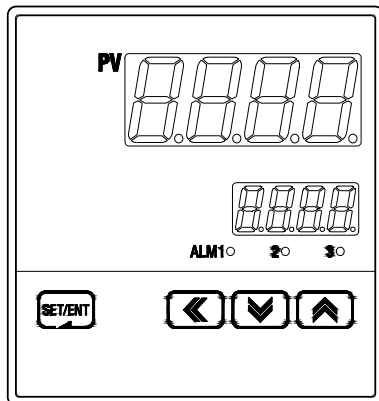

Control Keys

KEY	Contents
SET/ENT (ENTER)	Pressing SET/ENT key for at least 3 seconds switches between the operating display and the parameter setting display. This key is used to verify and bypass parameter settings when in the parameter group display.
▲ / ▼ (UP/DOWN)	Used to change the value of digits when setting parameters. Used to move between parameter groups.
◀ (SHIFT)	Used to move to the next digit when setting parameters.

LED Display

LED	Contents
ALM1, 2, 3	LEDs turn on when the corresponding alarm condition is in effect.

3. Parameter Map

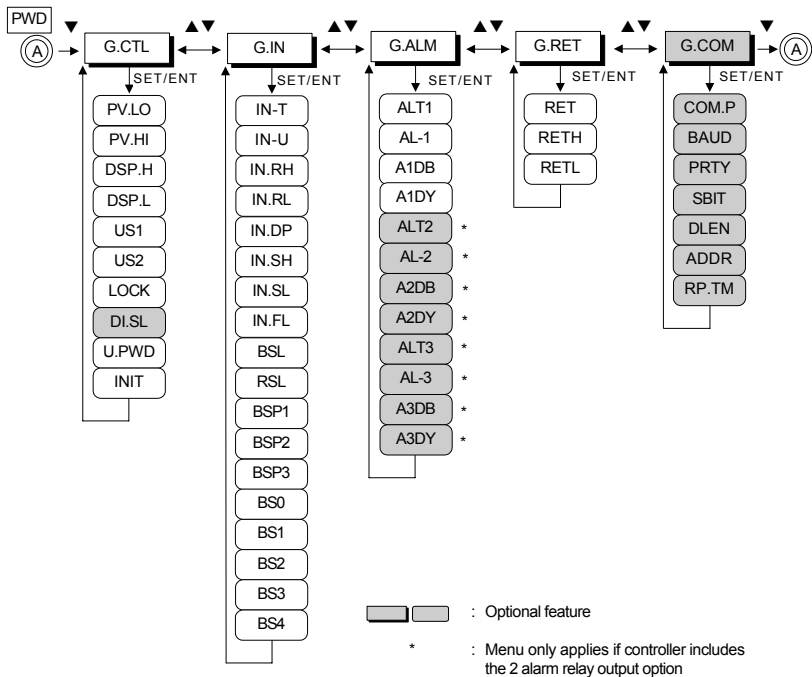

4. Operation Flow Chart

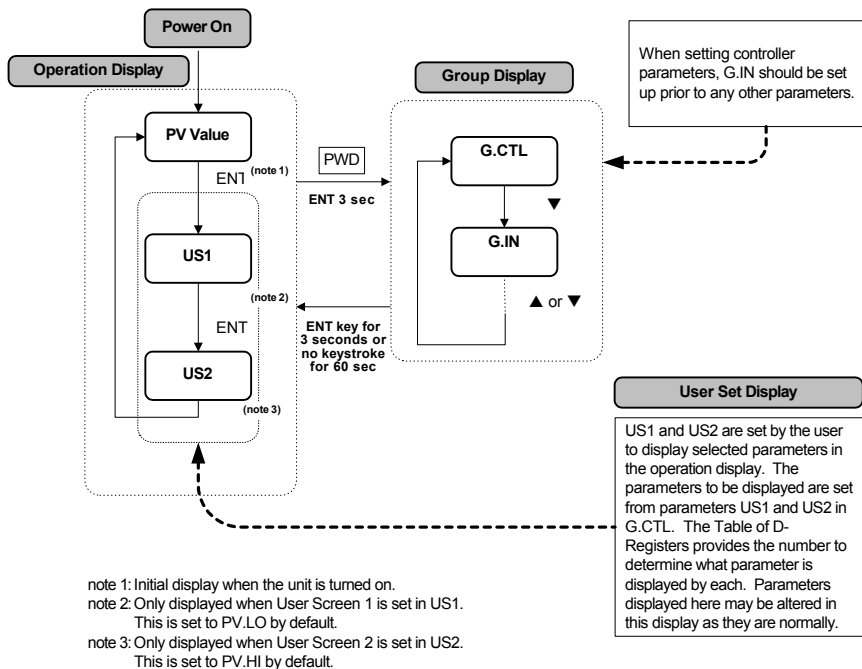

5. Parameter Setup

5.1 Input Group (G.IN)

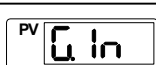

Press SET/ENT key to select input group. Press press ▲ or ▼ key to cycle through groups as shown below. (Refer to parameter map in section 3.)



Input group parameters should be established first, as changes to the input type may reset other parameter settings in other groups to their default value.

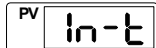





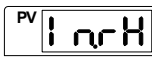
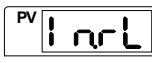

This parameter selects the type of input sensor used. Its default setting is type TC.K1. Refer to the following table showing the type of sensor inputs and select the desired input type.

Table 1: Universal Input Selection

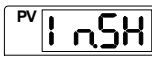
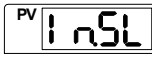
display range : -5% to 105%

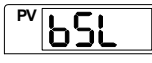
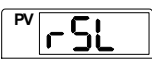
No.	TYPE	Temp.Range (°C)	Temp.Range (°F)	Group	DISP
1	K1	-200 to 1370	-300 to 2500	Thermocouple	TC.K1
2	K2	-199.9 to 999.9	0 to 2300		TC.K2
3	J	-199.9 to 999.9	-300 to 2300		TC.J
4	E	-199.9 to 999.9	-300 to 1800		TC.E
5	T	-199.9 to 400.0	-300 to 750		TC.T
6	R	0 to 1700	32 to 3100		TC.R
7	B	0 to 1800	32 to 3300		TC.B
8	S	0 to 1700	32 to 3100		TC.S
9	L	-199.9 to 900.0	-300 to 1600		TC.L
10	N	-200 to 1300	-300 to 2400		TC.N
11	U	-199.9 to 400.0	-300 to 750		TC.U
12	W	0 to 2300	32 to 4200		TC.W
13	Platinel II	0 to 1390	32 to 2500		TC.PL
14	PIA	-199.9 to 850.0	-300 to 1560	RTD (0.00385)	PTA
15	PIB	-199.9 to 500.0	-199.9 to 999.9		PTB
16	PIC	-19.99 to 99.99	-4.0 to 212.0		PTC
17	JPIA	-199.9 to 500.0	-199.9 to 999.9	RTD (0.00392)	JPTA
18	JPIB	-150.0 to 150.0	-199.9 to 300.0		JPTB
19	0.4 to 2.0V	0.400 to 2.000V		VDC	2V
20	1 to 5V	1.000 to 5.000V			5V
21	0 to 10V	0.00 to 10.00V			10V
22	-10 to 20mV	-10.00 to 20.00mV		mVDC	20M
23	0 to 100mV	0.0 to 100.0mV			100M

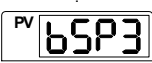
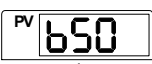
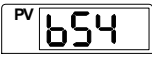
	<p>This parameter sets the display temperature unit for °C or °F. Its default selection is °C. Refer to Table 1 when changing the temperature unit for the temperature input range.</p>
	<p>This parameter sets the high limit of the temperature display range (maximum temperature displayed). For mV and V inputs, this sets the value of the high input of the input scale defined in In.SH.</p>
	<p>This parameter sets the low limit of the temperature display range (minimum temperature displayed). For mV and V inputs, this sets the low input of the input scale defined in In.SL.</p>
	<p>This parameter sets the position of the decimal point for mV or V inputs. The position of the decimal point can be set as 9999, 999.9, 99.99, or 9.999. Its default set value is 1.</p>
	<p>This parameter sets the high limit of the mV or V display scale. This value will be displayed when the input is set to the high input established in In.r.H. Its default value is 100.0.</p>
	<p>This parameter sets the low limit of the mV or V display scale. This value will be displayed when the input is set to the low input established in In.r.L. Its default value is 0.0.</p>
	<p>This parameter sets the PV filter for stabilization from electromagnetic noise and interference. This will effect the rate of change of the PV display value. Its default setting is OFF, and can be set from 1 to 120 seconds.</p>
	<p>This parameter to establishes PV behavior when an open input sensor is detected. When BSL is set to UP, the PV operates as if at the high input range. When BSL is set to DOWN, the PV operates as if at the low input range. Its default setting is UP. In the case of mV or V inputs, the default setting is OFF. An open sensor check is not performed in 10 V, 20 mV, or 100 mV input settings.</p>
	<p>This parameter determines if RJC for thermocouple inputs is used. RJC can be turned on or off. Its default setting is ON.</p>
 <p style="text-align: center;">⋮</p> 	<p>This parameter sets where the PV bias points occur. See Fig 1 and Fig 2 for further information about input bias operation.</p>
 <p style="text-align: center;">⋮</p> 	<p>This parameter sets the bias value at the corresponding bias point input values. These parameters establish the value of the offset at each of the defined BSP1 - BSP3 points. See Fig 1 and Fig 2 for further information about input bias operation.</p>

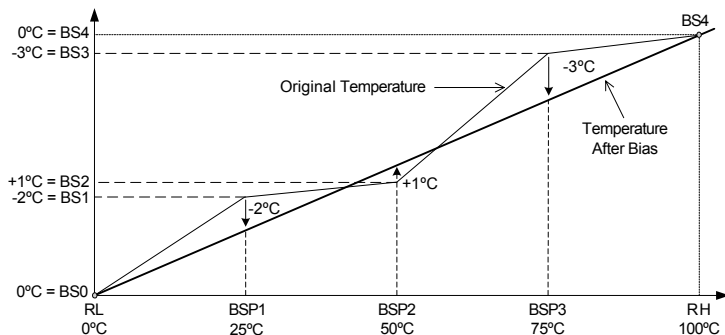

Fig 1: Temperature Bias

Example 1: The original temperature is shown within the range of 0°C (Range Low) and 100°C (Range High). Bias points have been used to adjust the displayed temperature as shown in the graph in Fig 1.

To establish this bias, the settings are shown below.

Temperature Settings to Establish Where the Bias Occurs				
RL	BSP1	BSP2	BSP3	RH
0°C	25°C	50°C	75°C	100°C
Bias Offset for Each Point				
BS0	BS1	BS2	BS3	BS4
0°C	-2°C	+1°C	-3°C	0°C

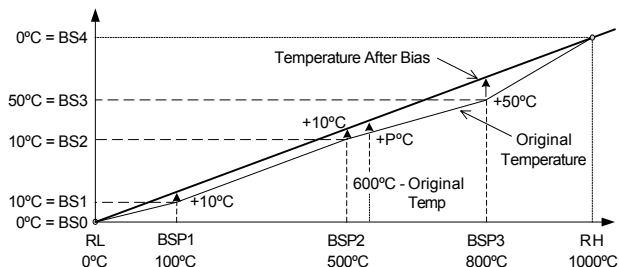

Fig 2: Bias Formula Calculation

Example 2: Temperature Bias Value (BS0 through BS4) = Temperature After Bias - Actual Temperature
 Display temperature after bias at 600°C actual temperature = P

$$P = 600 + (600 - BPS2) \times \frac{BS3 - BS2}{BSP3 - BSP2} + BS2$$

$$P = 600 + (600 - 500) \times \frac{50 - 10}{800 - 500} + 10 = 623^\circ\text{C Temperature After Bias}$$

Input Group Parameter Summary

Display	Parameter	Setting Range	Unit	Default	Remark
IN-T	Input Type	Refer to Table 1: Universal Input Selection	ABS	TC.K1	
IN-U	Display Unit	°C / °F	ABS	°C	T/C, RTD
IN.RH	Max PV Display Range	Within sensor input range Refer to Table 1 INRH > INRL	AEU	1370	
IN.RL	Min PV Display Range		AEU	-200	
IN.DP	Decimal Point Position	0, 1, 2, or 3	ABS	1	mV, V
IN.SH	Max Input Value Scale	-1999 to 9999 INSH > INSL Decimal position determined by IN.DP	ABS	100.0	mV, V
IN.SL	Min Input Value Scale			0.0	mV, V
IN.FL	PV Filter	OFF, 1 to 120	sec	OFF	
BSL	Open Sensor Behavior	OFF, UP, DOWN	ABS	UP	Not Used for VDC Input
RSL	RJC Operation	ON, OFF	ABS	ON	Only Used for TC Input
BSP1	Reference Bias Point 1	AEU (0.0 to 100.0%), RL≤BSP1≤BSP2≤BSP3≤RH	AEU	AEU (100.0%)	
BSP2	Reference Bias Point 2	AEU (0.0 to 100.0%), RL≤BSP1≤BSP2≤BSP3≤RH	AEU	AEU (100.0%)	
BSP3	Reference Bias Point 3	AEU (0.0 to 100.0%), RL≤BSP1≤BSP2≤BSP3≤RH	AEU	AEU (100.0%)	
BS0	Bias Value for RL Point	GEU (-100.0 to 100.0%)	GEU	0	
BS1	Bias Value at BSP1	GEU (-100.0 to 100.0%)	GEU	0	
BS2	Bias Value at BSP2	GEU (-100.0 to 100.0%)	GEU	0	
BS3	Bias Value at BSP3	GEU (-100.0 to 100.0%)	GEU	0	
BS4	Bias Value at RH	GEU (-100.0 to 100.0%)	GEU	0	



There are two types of engineering units values used in the setting of parameters, absolute engineering units (AEU) and general engineering units (GEU). An AEU parameter is set using an absolute value engineering unit that represents a specific point, such as a specific temperature or voltage level. An GEU parameter is set using engineering units, however it is a general value, and not tied to any input or output level.

For example: When establishing input bias, parameter BSP1 sets the specific PV value where bias point one will occur. This parameter has a unit designation of AEU. BS1, the amount of offset at BSP1 is set in engineering units, however this parameter occurs at whatever BSP1 is set to, and therefore does not have an absolute setting related to any input or output, it is just the amount of offset at where BSP1 occurs. While one is related to an absolute input value, and the other stand alone value, both are set as engineering units, such as BSP1 set as 100°C and BS1 set as 3°C.

5.2 Control Group (G.CTL)









	<p>Press SET/ENT key to select control group. (Refer to parameter map in section 3.)</p> <pre> ▲▼ PWD ↔ <u>G.CTL</u> ↔ G.IN ▲ ▲ ▲ ▲ ▼ ▼ ▼ ▼ G.COM ↔ G.RET ↔ G.ALM ▲▼ </pre>
	<p>This parameter displays the lowest input value that has occurred. It stores this information until the unit is turned off. The digital input option can be used to reset the minimum input value stored by this parameter.</p>
	<p>This parameter displays the highest input value that has occurred. This information is stored in memory until the unit is turned off. The digital input option can be used to reset the maximum input value stored by this parameter.</p>
 	<p>This parameter establishes the user screens for viewing, confirmation, and setup of commonly used parameters from the operation display. To add the parameter to the operation display, enter the corresponding number for the parameter from the Table of D-Registers as either US1 or US2. The default settings are OFF.</p> <p>☞ See page 12 and the Operation Flow Chart for a map of the operation display.</p>
	<p>Turning ON this parameter locks all settings from being changed. This applies to the operation display functions, such as changing the set point, as well as setting group parameters. If ON, only the LOCK parameter may be changed. The default setting is OFF.</p>
	<p>This parameter establishes the operation of the digital input (DI) external contacts. The digital input operating configurations are shown in Table 2: DI Operation. This feature is only valid for models with digital inputs.</p>

Table 2: DI Operation

DI.SL	DI1	DI2	Operation
OFF	-	-	DI Disabled
1	off	-	Reset min/max input values
	on	-	Record min/max input values
2	off	-	Reset minimum input value
	on	-	Record minimum input value
	-	off	Reset maximum input value
	-	on	Record maximum input value

	<p>This parameter sets the high limit of the sensor input in the PV display. The PV value will not display higher than this limit, however the control functions will operate based on the actual input value.</p>
	<p>This parameter sets the low limit of the sensor input in the PV display. The PV value will not display lower than this limit, however the control functions will operate based on the actual input value.</p>
	<p>This parameter establishes the password for the controller. This password must be entered at the PWD screen before accessing the control group (G.CTL) or it will not access the setting groups after the PWD prompt. The default setting is "0". See the parameter map in section 3 for the location of the PWD prompt in the group menus.</p>

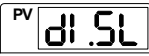

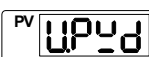
Be sure not to forget the password once it has been set. If the password is forgotten, contact technical support as listed on the back of this manual.

	<p>This parameter resets the input, alarm, and control parameters to their factory settings. To reset the controller, set this parameter to ON. After reset, it will return to the OFF setting.</p>
---	---









Most parameters will be reset to their default settings when the controller is initialized. Note the current settings before this is done so they can easily be restored after controller initialization.

Control Group Parameter Summary

Display	Parameter	Setting Range	Unit	Default	Remark
PV.LO	PV Low Value	AEU (-5.0 to 105.0%): Read Only	AEU	AEU (100.0%)	
PV.HI	PV High Value	AEU (-5.0 to 105.0%): Read Only	AEU	AEU (0.0%)	
US1	User Screen	OFF, D-Register No (1 to 1299)	ABS	OFF	
US2	User Screen	OFF, D-Register No (1 to 1299)	ABS	OFF	
LOCK	Parameter Lock	OFF, ON	ABS	OFF	
DI.SL	DI Selection	OFF, 1, 2 (See Table 2: DI Operation)	ABS	OFF	DI Option
DSP.H	Display High Limit	AEU (-5.0 to 105.0%), DSP.L<DSP.H	AEU	AEU (105.0%)	
DSP.L	Display Low Limit	AEU (-5.0 to 105.0%), DSP.L<DSP.H	AEU	AEU (-5.0%)	
U.P.W.D	User Password	0 to 9999	ABS	0	
INIT	Factory Initialization	OFF, ON	ABS	OFF	

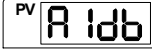
5.3 Alarm Group (G.ALM)

	<p>Press SET/ENT key to select alarm group. (Refer to parameter map in section 3.)</p> <div style="text-align: center;">  </div>
	<p>The parameter to establish the type of alarm to be used for alarm relay output 1 (ALARM1: relay output). The types of alarms selectable are shown in Table 3: Alarm Selection.</p>
	<p>The parameter to set the alarm trigger point for the alarm set in ALT1.</p>
	<p>The parameter to set the dead band (Hysteresis) of alarm 1.</p>
	<p>The parameter to set the delay time before of alarm 1 is triggered.</p>
<p style="text-align: center;">⋮</p>	<p>Note: The menus for alarm 2 and 3 are the same as alarm 1.</p>

 **Alarm Types and LED Display**
NOTE



- S indicates standby operation
- F for forward operation
r for reverse (failsafe) operation
- Decimal point always displayed
- H indicates a high alarm
L indicates a low alarm
- A indicates an absolute value alarm

Alarm Output Settings:

- Forward: Relay energized in alarm condition
- Reverse: Failsafe operation. Relay energized during normal operating conditions

Standby Operation:

The alarm will not trigger if the alarm condition occurs during the following activities...

- during power-up
- the set point is changed
- the type of alarm is changed

Table 3: Alarm Selection



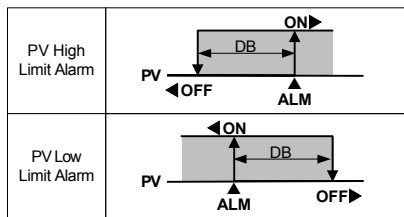

No.	Alarm Type	Operation		Standby		Display Data
		For	Rev	On	Off	
1	Absolute Value High Limit Alarm	✓		✓		AH.F
2	Absolute Value Low Limit Alarm	✓		✓		AL.F
3	Absolute Value High Limit Alarm		✓	✓		AH.R
4	Absolute Value Low Limit Alarm		✓	✓		AL.R
5	Absolute Value High Limit Alarm with Standby	✓			✓	AH.FS
6	Absolute Value Low Limit Alarm with Standby	✓			✓	AL.FS
7	Absolute Value High Limit Alarm with Standby		✓		✓	AH.RS
8	Absolute Value Low Limit Alarm with Standby		✓		✓	AL.RS

**Fig 3: Alarm Operation**

Alarm Group Parameter Summary

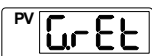
Display	Parameter	Setting Range	Unit	Default	Remark
ALT1	Alarm Type 1	Refer to Table 3: Alarm Selection	ABS	AH.F	
AL-1	Set Value of Alarm 1	AEU (-100.0 to 00.0%)	AEU	AEU (100.0%)	
A1DB	Alarm 1 DB	GEU (0.0 to 100.0%)	GEU	GEU (0.5%)	
A1DY	Delay Time of Alarm 1	0.00 to 99.59	MM.SS	0.00	
ALT2	Alarm Type 2	Refer to Table 3: Alarm Selection	ABS	AH.F	
AL-2	Set Value of Alarm 2	AEU (-100.0 to 00.0%)	AEU	AEU (100.0%)	
A2DB	Alarm 2 DB	GEU (0.0 to 100.0%)	GEU	GEU (0.5%)	
A2DY	Delay Time of Alarm 2	0.00 to 99.59	MM.SS	0.00	
ALT3	Alarm Type 3	Refer to Table 3: Alarm Selection	ABS	AH.F	
AL-3	Set Value of Alarm 3	AEU (-100.0 to 00.0%)	AEU	AEU (100.0%)	
A3DB	Alarm 3 DB	GEU (0.0 to 100.0%)	GEU	GEU (0.5%)	
A3DY	Delay Time of Alarm 3	0.00 to 99.59	MM.SS	0.00	

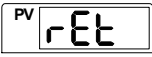
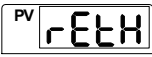
5.4 Retransmission Group (G.RET)

	<p>Press SET/ENT key to select retransmission group. (Refer to parameter map.)</p> <div style="text-align: center;">  </div>
	<p>This parameter explains the type of retransmission scale used. The retransmitting output is based on the PV. See the graphic below for additional explanation of the retransmission outputs and how they are scaled. This setting is always set to PV.</p>
 	<p>These parameters are used to scale the retransmitting output. They set the high and low limits for the retransmission output scale, as shown below. The retransmitting outputs will transmit 4 mA at the low limit (RETL) and 20 mA at the high limit (RETH) values.</p>



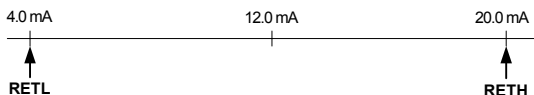

**PV Retransmission Scale**

The PV Retransmitting outputs transmit a 4 to 20 mA signal. The 4 mA signal is transmitted when the PV is equal to the value set in RETL, and 20 mA is transmitted when the PV is equal to the value set in RETH. Note that RETL and RETH are limited by the maximum and minimum input ranges as setup in INRH and INRL, or INSH and INSL.

**Retransmission Group Parameter Summary**

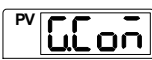
Display	Parameter	Setting Range	Unit	Default	Remark
RET	Select RET	PV	ABS	PV	
RETH	Ret Scale High Limit	T/C, RTD: INRH to INRL mV, V: INSH to INSL RETH > RETL	AEU	INRH	
RETL	Ret Scale Low Limit		AEU	INRL	

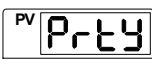
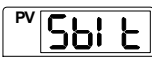
5.5 Communication Group (G.COM)

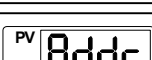
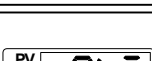
	<p>Press SET/ENT key to select communication group. (Refer to parameter map.)</p> <pre> ▲▼ ▲▼ ▲▼ PWD ↔ G.CTL ↔ G.IN ▲▼ ▲▼ ▲▼ ↑ G.COM ↔ G.RET ↔ G.ALM ▲▼ ▲▼ </pre>
	<p>The parameter to select the type of communication protocol to be used.</p>
	<p>The parameter to set the communication speed (baud rate). The baud rate can be set at 600 to 19200 bps (bytes per second). The default setting is for 9600 bps.</p>
	<p>The parameter to set communication parity. This can be set to NONE, EVEN, or ODD. The default setting is NONE.</p>
	<p>The parameter to set the communication stop bit. This can be set as 1 or 2. It is initially set as 1.</p>
	<p>The parameter to set the communication data length. This can be set to 7 or 8. The default setting is 8. This parameter is not displayed when the communication protocol (COM.P) is set for MODBUS ASCII or RTU.</p>
	<p>The parameter to set the communication address for the controller. This can be set as 1 to 99 pcs address. Its default setting is 1.</p>
	<p>The parameter to set communication response time. The RP.TM is the delay to return data to the upper level device after processing commands received from the upper level device. The setting RP.TM is based on the number of 10 ms intervals to delay (example: a setting of 2 will result in a 20 ms delay). If RP.TM is set to 0 it will immediately return a response once the command processing is complete.</p>



Request or download copies of the Precision Digital Nova Communication Manual for additional details about serial data communications with Precision Digital Nova products.

Communication Group Parameter Summary

Display	Parameter	Setting Range	Unit	Default	Remark
COM.P	Communication Protocol	PCC0, PCC1, MODBUS ASCII, MODBUS RTU	ABS	PCC0	Option
BAUD	Baud Rate	600, 1200, 2400, 4800, 9600, 19200	ABS	9600	Option
PRTY	Parity	None, Even, Odd	ABS	None	Option
SBIT	Stop Bit	1, 2	ABS	1	Option
DLEN	Data Length	7, 8 (not used when set for MODBUS)	ABS	8	Option
ADDR	Address	1 to 99 (maximum of 31 connected at once)	ABS	1	Option
RP.TM	Response Time	0 to 10 (number of 10ms intervals)	ABS	0	Option

6. Error Display and Correction

Error Message	Error Incident	Action Needed
E.SYS	EEPROM, DATA Loss	Needs Repair
E.RJC	RJC Sensor Failure	Needs Repair
SP Decimal Flashing	Communication Failure	Check Comm Cable
S.OPN	Open Sensor Detected	Check Sensor

7. Installation

7.1 Dimensions and Panel Cutouts

PD568

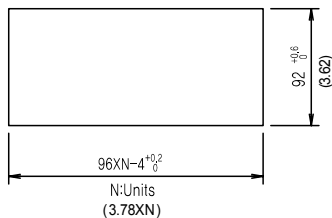
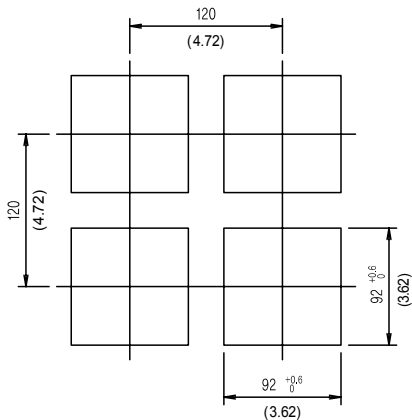
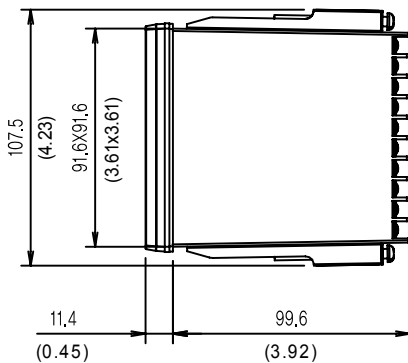
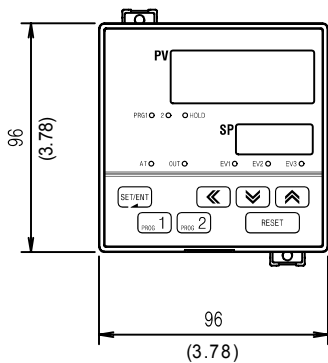

Units: mm
(inch) - for reference only

PD562

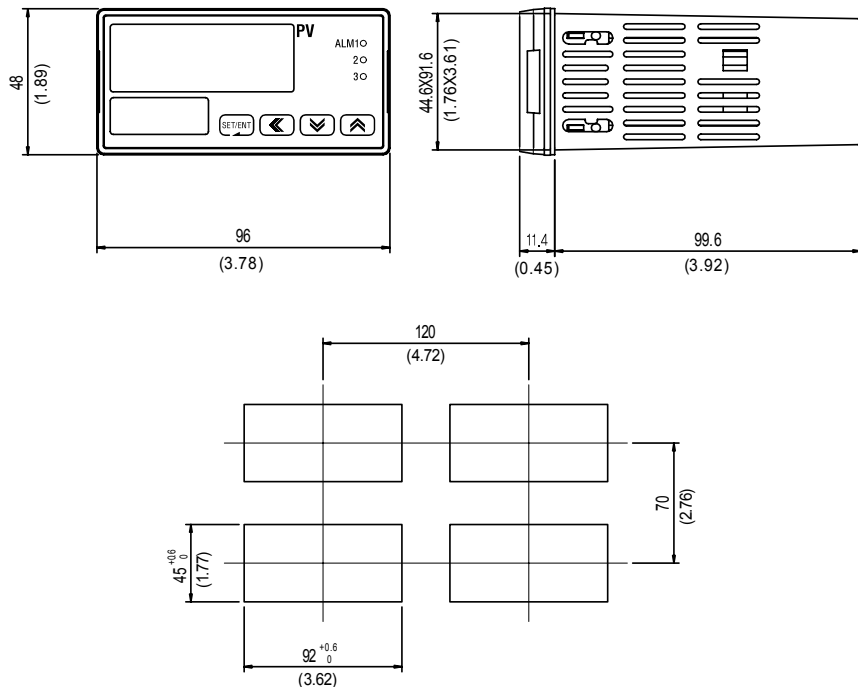

mm
(inch) - for reference only

7.2 Panel Mounting

PD568

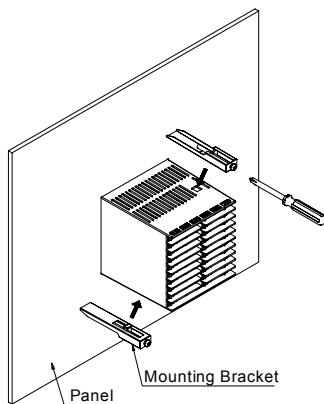

PD562

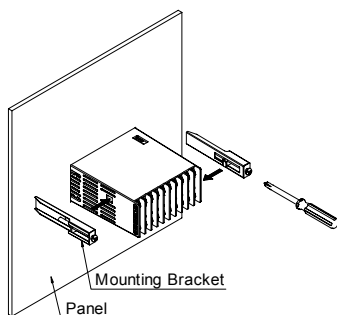

Installation Steps

1. Cut the mounting panel. (Refer to 7.1 Dimensions and Panel Cutouts)
2. Insert the controller through the front of the panel rear terminals first.
3. On applicable models, attach the right and left mounting bracket and secure it to the panel.



Do not excessively tighten the mounting bracket screws. Excessive tightening may lead to controller or panel damage.

7.3 Power Cable Specification

Make power connections using 0.9 to 2.0 mm² or 16 AWG vinyl insulated wire. (Voltage rating of 300 VAC)

7.4 Terminal Specification

Use M3.5 screw-compatible crimp on terminals with insulating sleeve as shown below.

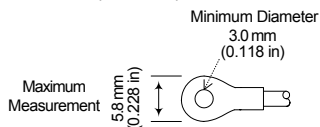

Note: Inches for reference only.

Use copper conductors only if the terminal is for connection to copper wire only.



Always turn off the source circuit breaker and check to ensure the power is off to the controller through the use of a tester prior to working on the wiring terminals.

- Never touch the terminals in the rear panel when power is supplied to the controller.
- Be sure to turn off the electric power before wiring any terminals.



Bind the wires connected to the controller terminals neatly together in order to prevent electromagnetic interference.

7.5 Terminal Assignment, Connections, and Ratings

PD568

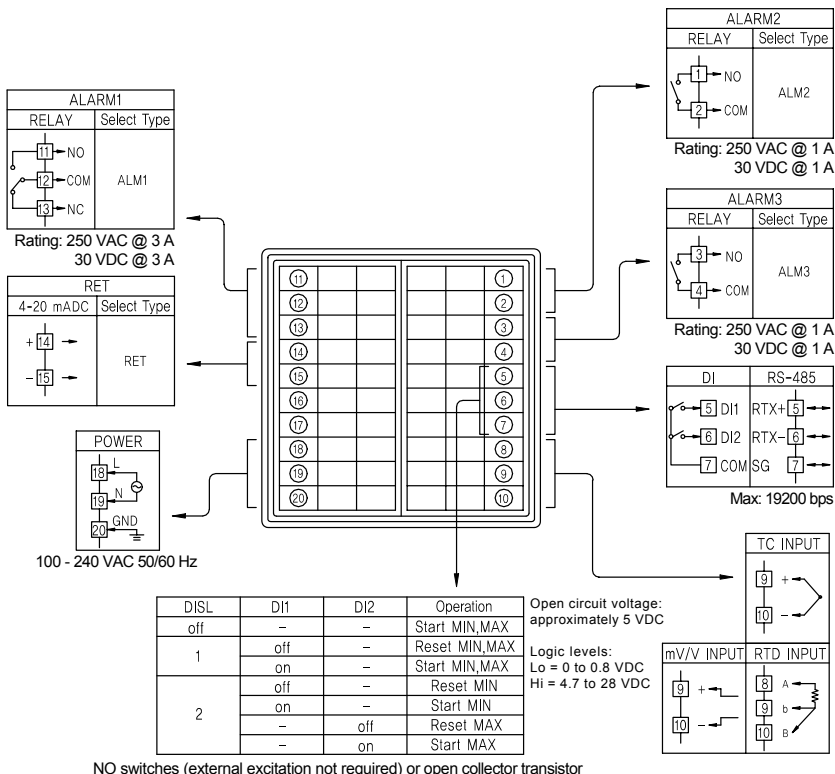

PD562

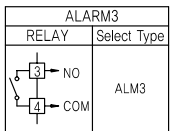

Rating: 250 VAC @ 1 A
30 VDC @ 1 A

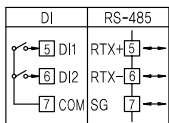

Max: 19200 bps

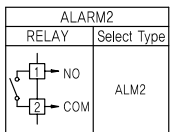
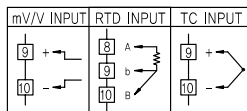

Rating: 250 VAC @ 1 A
30 VDC @ 1 A

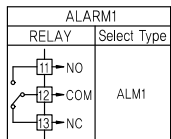
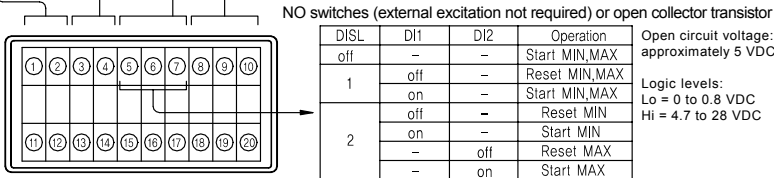

Rating: 250 VAC @ 3 A
30 VDC @ 3 A

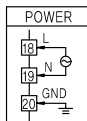
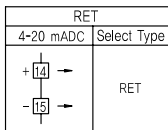

100 - 240 VAC 50/60 Hz

7.6 Grounding and Power Cable Connection

- Use a thick grounding cable of at least 2 mm² or 14 AWG and shorter than 20 m (approximately 22 ft) for class-3 grounding or better with a grounding resistance of less than 100 Ω.
- Be sure to ground from the grounding terminal to an independent grounding point. (1 point grounding)
- Use 0.9 to 2.0 mm² or 16 AWG vinyl insulated wire (Voltage rating 300VAC) or thicker for power cable connection.

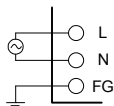

Be sure to connect L (Hot), N (neutral), and GND (ground) as indicated. Failure to wire the power and ground as indicated could result in damage to the controller.



To prevent electric shock, be sure to turn off power to the Nova Controller and the source circuit breaker before wiring.



- Be sure to connect to correct polarities. Connecting to a wrong polarity may cause damage or malfunction.
- Use shielded wires and ground the shielding to an independent grounding point.
- Keep the input signal and output wiring as far as possible away from the power and ground circuit.
- Use a wire with low conductive resistance and no three-wire resistance differential.

7.7 Signal Input Connection

(1) RTD Input

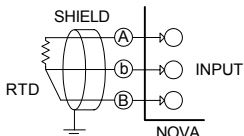

(2) DC Voltage Input

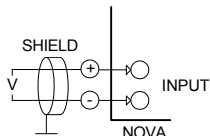

(3) DC Current Input

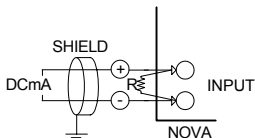

To accept a 4-20 mA signal, select 0.4 to 2.0 VDC input and connect a 100 Ω resistor across the input terminals as shown.

7.8 Retransmission Output Connection.(RET)



To prevent electric shock, be sure to turn off power to the Nova Controller and the source circuit breaker before wiring.



- Be sure to connect to correct polarities. Connecting to a wrong polarity may cause a controller malfunction.
- Use shielded wires for the wiring and connect independently to ground (1 point grounding).

Retransmitting Output (RET)

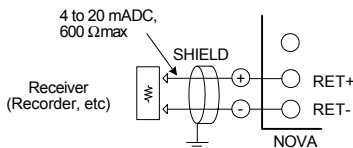

To prevent electric shock, be sure to turn off power to the Nova Controller and the source circuit breaker before wiring.

7.9 Relay Output Connection (RELAY)

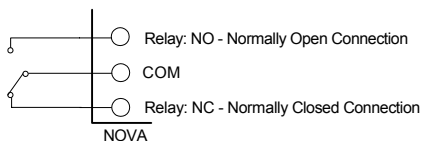

To prevent electric shock, be sure to turn off power to the Nova Controller and the source circuit breaker before wiring.

7.10 Digital Input Connection (DI)

- Use a no-voltage contact switch such as relay.
- The controller supplies the needed voltage (approx. 5 VDC) and current (approx. 1 mA) to trigger the input.
- When using an Open Collector (TR) as a trigger, use one with a 2V or lower voltage rating when "on" and 100 μ A or less leakage current when it is OFF.

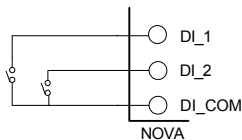

▲ Relay Contact Connection

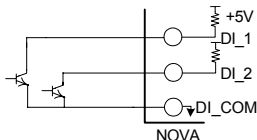

▲ Transistor Contact Connection



To prevent electric shock, be sure to turn off power to the Nova Controller and the source circuit breaker before wiring.

7.11 Use of an External Relay

Switching Inductive Loads

When using switching inductive loads, the use of RC networks (snubbers) for AC loads or diodes for DC loads is recommended to prevent disrupting the microprocessor's operation. The suppressors also prolong the life of the relay contacts. Suppression can be obtained with resistor-capacitor (RC) networks or diodes assembled by the user or purchased as complete assemblies.

For AC loads, choose R and C as follows:

R: 0.5 to 1 Ω for each volt across the contact

C: 0.5 to 1 μ F for each amp through closed contacts

Notes:

1. Use capacitors rated for 250 VAC.
2. RC networks may affect load release time of solenoid loads. Check to confirm proper operation.
3. RC networks are available from Precision Digital and should be applied to each relay contact switching an inductive load. Part number: PDX6901.



If the load inductance is over the controller specifications, the output may need a RC filter (snubber) or diode to properly handle frequent relay switching operations.

(1) DC External Relay

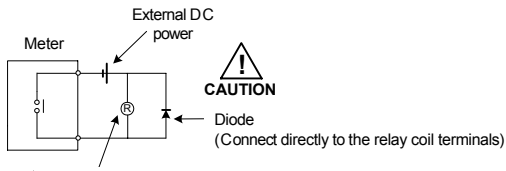

Relay
(Verify relay coil ratings are less than the voltage and current ratings of the relay contacts of the controller)

(2) AC External Relay

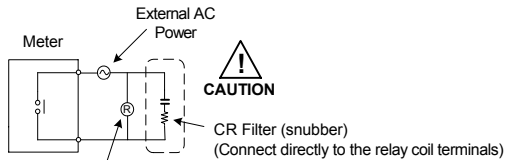

Relay
(Verify relay coil ratings are less than the voltage and current ratings of the relay contacts of the controller)

7.12 Communication Wiring (RS-485)

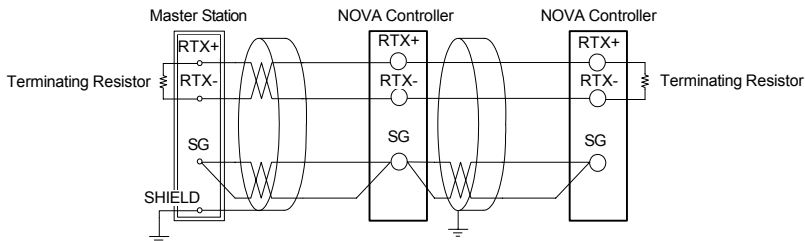

- Up to 31 slave controllers (Nova series controllers equipped with the RS-485 serial communication option) can be connected.
- Be sure to connect terminating resistors (220 Ω , 1/4 W) to slave and master controllers at communication channel ends as shown above.



To prevent electric shock, be sure to turn off power to the Nova Controller and the source circuit breaker before wiring.

Table of D-Registers

NO.	PROCESS	FUNCTION	SET POINT	SIGNAL	ALARM	PID	IN/OUT
	0	100	200	300	400	500	600
0							
1	NPV				ALT1		IN-T
2					ALT2		INT-U
3					ALT3		IN.RH
4							IN.RL
5							IN.DP
6					AL-1		IN.SH
7					AL-2		IN.SL
8					AL-3		IN.FL
9							BSL
10							RSL
11					A1DB		BSP1
12					A2DB		BSP2
13					A3DB		BSP3
14	ALSTS						
15							BS0
16					A1DY		BS1
17					A2DY		BS2
18					A3DY		BS3
19	ERROR						BS4
20							
21					AL1.H		
22	PV.LO				AL2.H		
23	PV.HI				AL3.H		
24							
25							
26					AL1.L		
27					AL2.L		
28					AL3.L		
29							
30							
31							
32							
33							
34							
35		US1					
37		US2					
36		LOCK					
38		DI.SL					
39		DSP.H					
40		DSP.L					
41							
42							
43							

NO.	PROCESS	FUNCTION	SET POINT	SIGNAL	ALARM	PID	IN/OUT
	0	100	200	300	400	500	600
44							
45							
46							
47							
48							
49							
50							
51							RET
52							RETH
53	U						RETL
54	s						
55	e						
56	r						
57							
58	A						
59	r						
60	e						
61	a						COM.P
62							BAUD
63							PRTY
64							SBIT
65							DLEN
66							ADDR
67							RP.TM
68							
69							
70							
71							
72							
73							
74							
75							
76							
77							
78							
79							
80							
81							
82							
83							
84							
85							
86							
87							

NO.	PROCESS	FUNCTION	SET POINT	SIGNAL	ALARM	PID	IN/OUT
	0	100	200	300	400	500	600
88							
89							
90							
91							
92							
93							
94							
95							
96							
97							
98							
99							



NOTE

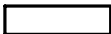

Read Only Location

Notes



Warranty and Return Information

Precision Digital warrants this product to be free from material defects and workmanship under normal use and service for three years.

Please contact Precision Digital Technical Support at (800) 610-5239 or e-mail at support@predig.com prior to any product return. When Technical Support determines a product should be returned, a Return Material Authorization (RMA) # which must be included on the return shipping label. Please also include the reason for return, date of purchase, contact name, and how to contact. Products returned for reasons other than repair may be subject to a restocking fee. Any returns under a warranty claim should be returned freight prepaid. Upon warranty confirmation Precision Digital will repair or replace and return the unit at no charge via UPS Ground. Other shipping is available upon request and at customer expense. All product returns should be shipped to:

Return Authorization # _____

Precision Digital, 19 Strathmore Road, Natick, MA 01760 USA

Attention: Technical Support

Precision Digital Technical Support is trained and eager to serve you. We have found most start-up problems to be the result of incorrect signal connections and/or programming. Most often Precision Digital Technical Support can quickly correct these issues over the telephone.

How to Contact Precision Digital

- For Technical Support
Call: (800) 610-5239 or (508) 655-7300
Fax: (508) 655-8990
Email: support@predig.com
- For Sales Support or to place an order please
Call: (800) 343-1001 or (508) 655-7300
Fax: (508) 655-8990
Email: sales@predig.com
- For the latest version of this manual, please visit
www.predig.com