

PROGRAMMABLE CONTROLLER



NOVA PD550 Series

Instruction Manual

PD550 / 554 / 556 / 558

PRECISION DIGITAL CORPORATION

19 Strathmore Road • Natick MA 01760 USA

Tel (800) 343-1001 • Fax (508) 655-8990

**PRECISION
DIGITAL** 

Disclaimer

The information contained in this document is subject to change without notice. Precision Digital Corporation makes no representations or warranties with respect to the contents hereof, and specifically disclaims any implied warranties of merchantability or fitness for a particular purpose.

Registered Trademarks

MODBUS® is a registered trademark of Schneider Automation Inc. All other trademarks mentioned in this document are the property of their respective owners.

©2004 Precision Digital Corporation. All rights reserved.

Visit our Web Site
<http://www.predig.com>

Table of Contents

1. Safety Guide and Specifications	5
1.1 Specifications	7
2. Front Panel Buttons and LED Indicators	11
3. Parameter Map	12
4. Operation Flow Chart	14
5. Parameter Setup	15
5.1 Input Group (G.IN)	15
5.2 Output Group (G.OUT)	19
5.3 Control Group (G.CTL)	22
5.4 Program Group (G.PROG)	24
5.5 Digital Output Group (G.DO)	30
5.6 Inner Signal Group (G.IS)	31
5.7 PID Group (G.PID)	33
5.8 Auto-Tuning Group (G.AT)	35
5.9 Alarm Group (G.ALM)	37
5.10 Retransmission Group (G.RET)	40
5.11 Communication Group (G.COM)	41
6. Error Display and Correction	43
7. Installation	44
7.1 Dimensions and Panel Cutouts	44
7.2 Panel Mounting	48
7.3 Power Cable Specifications	49
7.4 Terminal Specifications	49
7.5 Terminal Assignment, Connections, and Ratings	50

7.6 Grounding and Power Cable Connection	54
7.7 Signal Input Connection	54
7.8 Analog Output Connection	55
7.9 Relay Output Connection (RELAY)	56
7.10 Digital Input Connection (DI)	56
7.11 Use of an External Relay	56
7.12 Communication Wiring (RS-485)	57

Appendix

Table of D-Registers	58
----------------------------	----

Tables and Figures

Table 1: Universal Input Selection	15
Table 2: DI Operation	22
Table 3: Link Codes	27
Table 4: DO Settings and Functions	30
Table 5: Alarm Selection	38
Fig 1: Temperature Bias	17
Fig 2: Bias Formula Calculation	17
Fig 3: Time-Proportional PID Control Output	20
Fig 4: Start Code SSP Start	24
Fig 5: Wait Function Wait Zone Release	26
Fig 6: Wait Function Wait Time Release	27
Fig 7: Inner Signal Zones	31
Fig 8: Overshoot Suppression with Fuzzy Logic	33
Fig 9: Auto-Tuning	35
Fig 10: Auto-Tuning Gain	36
Fig 11: Alarm Operation	38

1. Safety Guide and Specifications



The following safety symbols are used in this manual

- (1) This symbol notifies the user of specific information relating to the safe operation of the controller. Information noted with this symbol must be observed to protect the user from injury and to prevent damage to the product.
 - (A) For User: Be aware of this marking in the manual and refer to the explanation in the manual to prevent injury and damage.
 - (2) For Installer: Study the warnings marked to prevent injury and damage.



- (2) Functional earth terminal: This symbol indicates that the terminal must be connected to ground.



- (3) This symbol indicates additional information on the features of the product.



- (4) This symbol directs the reader to further information on the current topic.



Precautions Regarding This Instruction Manual

- (1) This manual must be kept in the possession of the end user and in a suitable place for the operator to study and to check the functions of the product.
- (2) The installer and operator should carefully study and understand how to operate this product before use.
- (3) This manual describes the functions of the product. Precision Digital Corporation does not guarantee that the functions will suit a particular purpose.
- (4) The contents of this manual have been reviewed for accuracy and correctness. However, should any errors or omissions come to the attention of the user, contact technical support as listed on the back of this manual.



Safety Procedures and Unauthorized Modification Warning

- (1) In order to protect this product and the system controlled by it against damage and ensure its safe use, make certain that all of the safety instructions and precautions in this manual are strictly adhered to.
- (2) Precision Digital Corporation does not guarantee safety if the products are not handled in accordance with this instruction manual.
- (3) If separate protection or safety circuits are to be installed in the system which is controlled by this product, ensure that such circuits are installed external to this product.
- (4) Do not make modifications or additions internally to the product. It may cause personal injury to the user or damage to the product.
- (5) Contact technical support as listed on the back of the manual for warranty and repair issues.
- (6) Exposure to excessive moisture, electrical overloads, or mechanical vibration may damage the product.



Limited Liability

Precision Digital Corporation assumes no liability to any party for any loss or damage, direct or indirect, caused by the use of or any unpredictable defect of the product.



Operational Environment Precautions

- (1) Only operate the controller when it is properly installed.
- (2) When installing the controller, select a location where:
 - Rear terminals are protected from accidental contact.
 - Mechanical vibrations are minimal.
 - No corrosive gas is present.
 - Temperature fluctuation is minimal.
 - Temperature can be maintained between 10 and 50 °C (50 and 110°F) with 20 to 90% RH.
 - No direct heat radiation is present.
 - High levels of electromagnetic interference are not present
 - The unit is not exposed to water.
 - No flammable materials are present.
 - Dust particles are not present in the air.
 - Exposure to ultraviolet rays is minimal.
 - Openings on the rear of the controller are not blocked.
- (3) This unit is suitable for installation in an environment classified as Pollution Degree 2.
- (4) This unit is designated as Installation Category II.
- (5) If the equipment is used in a manner not specified by the manufacturer, the protection provided by the equipment may be impaired.
- (6) A switch or circuit-breaker acting as the disconnect device shall be included in the application or the installation.



Controller Mounting Precautions

- Keep the input circuit wiring as far as possible away from power and ground circuits.
- Keep the units in 10 to 50°C (50 to 110°F) with 20% to 90% relative humidity (RH).

The controller may need a warm up period to return to operating temperature ranges when below 10°C.
- To prevent electric shock, be sure to turn off the power source and circuit breaker before wiring.
- The power requirements are 100 to 240 VAC, 50/60 Hz, 10 VA max. Do not switch power supplies without first disconnecting the power supply.
- Follow the operating procedures and precautions in the manual to avoid fire, shock, damage to the unit, or injury. Follow the operations and mounting directions indicated in this manual.
- Always create a ground connection where indicated, however do not ground to gas pipes, water pipes, lightning rods, or other potentially hazardous metal objects.
- Do not apply power to the unit until all connections have been made.
- Do not cover the venting holes in the rear of the unit.

1.1 SPECIFICATIONS

Except where noted all specifications apply to operation at 23°C.

General

DISPLAY	Two four digit red LED displays (-1999 to 9999) 1/16 DIN PV 11.3 mm (0.45 in), SP 9.5 mm (0.37 in) 3/16 DIN PV 14.0 mm (0.55 in), SP 12.0 mm (0.47 in) 1/8 DIN PV 13.6 mm (0.54 in), SP 10.5 mm (0.41 in) 1/4 DIN PV 20.5 mm (0.81 in), SP 11.0 mm (0.43 in)
SAMPLING TIME	250 ms
OVERRRANGE	Relays trip and PV display reads 9999
PROGRAMMING METHODS	Four front panel buttons, digital inputs, PC software
PID ZONES	3 programmable PID zone ranges, 1 PID PV deviation zone
NOISE FILTER	Programmable from 1 to 120.
RECALIBRATION	All ranges are calibrated at the factory. Recalibration is not required.
PASSWORD	Programmable password restricts modification of programmed settings.
POWER	100-240 VAC, 50/60 HZ, 10 Watts
FUSE	Required fuse: UL Recognized, 5 A max, slow blow Up to six units may share one 5 A fuse
ISOLATION	1.5 kV input/output-to-power line 500 V input-to-output
PROGRAMMING CAPACITY	2 set point program patters of 15 segments each Segment repeat and program loop functions
ENVIRONMENTAL	Operating temperature range: 10°C to 50°C (50°F to 110°F) Relative humidity: 20 to 90% non-condensing
MOUNTING	1/16, 3/16, 1/8, or 1/4 DIN size cutout required Two panel mounting bracket assemblies provided One one-piece bracket provided for the PD550
WARRANTY	Three years parts and labor
EXTENDED WARRANTY	Extended parts and labor warranties are available at time of ordering

Process and Temperature Inputs

TEMPERATURE DRIFT	Refer to accuracy specifications below
DECIMAL POINT	Up to three decimal places for process inputs: 9.999, 99.99, 999.9, or 9999
REAR JUNCTION COMPENSATION	Automatic or off settings for temperature inputs. No user calibration required.
OFFSET ADJUSTMENT	Four programmable input bias points, each with a programmable offset value.
SENSOR BREAK DETECTION	Open sensor indicated by PV display flashing S.OPN All PID control outputs transmit at the user programmed percent of full output scale set in parameters Po.

UNIVERSAL INPUT TYPE AND ACCURACY

		Temp Range (°C)	Temp Range (°F)	Accuracy*	
Input Type	Thermocouple	K1	-200 to 1370	Temp Ranges > 0°C : ±0.1% ±1 digit Temp Ranges < 0°C : ±0.2% ±1 digit	
		K2	-199.9 to 999.9		
		J	-199.9 to 999.9		
		T	-199.9 to 400.0		
		B	0 to 1800	32 to 3300	Temp Ranges > 400°C : ±0.15% ±1 digit Temp Ranges < 400°C : ±5% ±1 digit
		R	0 to 1700	32 to 3100	All Temp Ranges ±0.15% ±1 digit
		S	0 to 1700	32 to 3100	
		E	-199.9 to 999.9	-300 to 1800	Temp Ranges > 0°C : ±0.1% ±1 digit Temp Ranges < 0°C : ±0.2% ±1 digit
		L	-199.9 to 900.0	-300 to 1600	
		U	-199.9 to 400.0	-300 to 750	
N	-200 to 1300	-300 to 2400	Temp Ranges > 0°C : ±0.1% ±1 digit Temp Ranges < 0°C : ±0.25% ±1 digit		
W	0 to 2300	32 to 4200	All Temp Ranges ±0.2% ±1 digit		
Platinel II	0 to 1390	32 to 2500	All Temp Ranges ±0.1% ±1 digit		
RTD	PIA	-199.9 to 850.0	-300 to 1560	**All Temp Ranges ±0.1% ±1 digit	
	PIB	-199.9 to 500.0	-199.9 to 999.9		
	PIIC	-19.99 to 99.99	-4.0 to 212.0	All Temp Ranges ±0.2% ±1 digit	
	JPIA	-199.9 to 500.0	-199.9 to 999.9	**All Temp Ranges ±0.1% ±1 digit	
JPIB	-150.0 to 150.0	-199.9 to 300.0			
DC Voltage	0.4 to 2.0 V	0.400 to 2.000	All Voltage Ranges ±0.1% ±1 digit Display range can be scaled between -1999 and 9999. To accept a 4-20 mA signal, select 0.4 to 2.0 VDC input and connect a 100 resistor across the input terminals.		
	1 to 5 V	1.000 to 5.000			
	0 to 10 V	0.00 to 10.00			
	-10 to 20 mV	-10.00 to 20.00			
	0 to 100 mV	0.0 to 100.0			

*Performance within recommended operating conditions (10 to 50°C, 20 to 90% RH)

**For a range scale of 0 to 100°C: +0.3°C +1 digit, and for a range scale of -100 to 100°C: +0.5°C +1 digit

Relay Outputs

RATINGS	Out1: 250 VAC @ 3 A or 30 VDC @ 3 A (resistive load) Sub1, Sub2: 250 VAC @ 1 A or 30 VDC @ 1 A (resistive load)
ELECTRICAL NOISE SUPPRESSION	A suppressor (snubber) should be connected to each relay contact switching inductive loads, to prevent disruption to the microprocessor's operation. Recommended suppressor value: 0.1 μ F/470 Ω , 250 VAC (PDX6901)
DEADBAND	For alarm operations, 0-100% of full scale, user selectable
HIGH OR LOW ALARM	User may program any relay for high or low trip point.
DEVIATION ALARM	User may program any relay for a high, low, or range set point deviation alarm.
RELAY OPERATION	Any relay may be set as a alarm relay or for time proportional PID control,
TIME DELAY	0 to 99 minutes 59 seconds alarm trip delay user selectable for each alarm. Time proportional PID control relay activation time delay of 0 to 99 minutes 59 seconds user selectable.
FAIL-SAFE OPERATION	Programmable, standby option independant for each alarm
AUTO INITIALIZATION	When power is applied to the controller, alarm relays will reflect the state of the input to the controller except standby alarms.

Analog Outputs

OUTPUT RANGE	Continuous PID or retransmitting: 4-20 mA (600 Ω maximum) Time Proportional PID: 15 VDC pulse (600 Ω minimum, current limited at 30 mA) high, less than 0.1 VDC low, cycle time 1 to 300 seconds, user selectable
SCALING RANGE	Retransmitting 4-20 mA outputs can be scaled for any display range low and high.
ACCURACY	$\pm 0.1\%$ of full scale

Serial Communications

PROTOCOLS	Modbus (ASCII, RTU), PC software, SYNC (master/slave SP control)
UNIT ADDRESS	1 to 99 (Max 31 units connected)
BAUD RATE	600, 1200, 2400, 4800, 9600, 19200 bps, user selectable
RESPONSE TIME	0 to 100 ms delay response time 10 ms increments user selectable
DATA	7 or 8 bit user selectable
PARITY	None, even, or odd

Approvals

UL RECOGNIZED	USA and Canada UL 3121-1, Process Control Equipment
UL FILE NUMBER	E244207
CE COMPLIANT	

2. Front Panel Buttons and LED Indicators

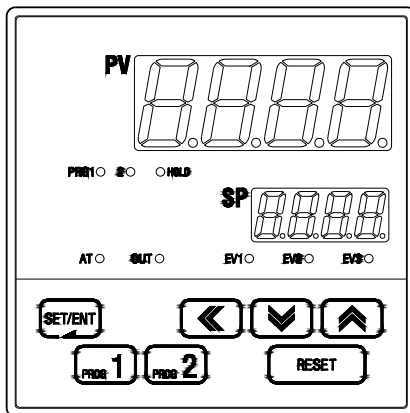

Control Keys

KEY	Contents
SET/ENT (ENTER)	Pressing SET/ENT key for at least 3 seconds switches between the operating display and the parameter setting display. This key is used to verify and bypass parameter settings when in the parameter group display.
▲ / ▼ (UP/DOWN)	Used to change the value of digits when setting parameters. Used to move between parameter groups.
◀ (SHIFT)	Used to move to the next digit when setting parameters.
PRG1 (P1) PRG2 (P2) RESET (RST)	Pressing program button 1 for 1 second runs program 1. Pressing program button 2 for 1 second runs program 2. Pressing the reset button for 1 second after a program runs will reset the controller to "STOP" mode and end all programs.

LED Display

LED	Contents
EV1,2,3 OUT AT PRG1 PRG2 HOLD	LEDs light when corresponding relay events occur, such as alarm conditions. LED light to display when control output is active. LED light when auto-tuning is in process. LED lights while program 1 is running. LED lights while program 2 is running. LED lights when the program has been paused through the HOLD feature.

3. Parameter Map

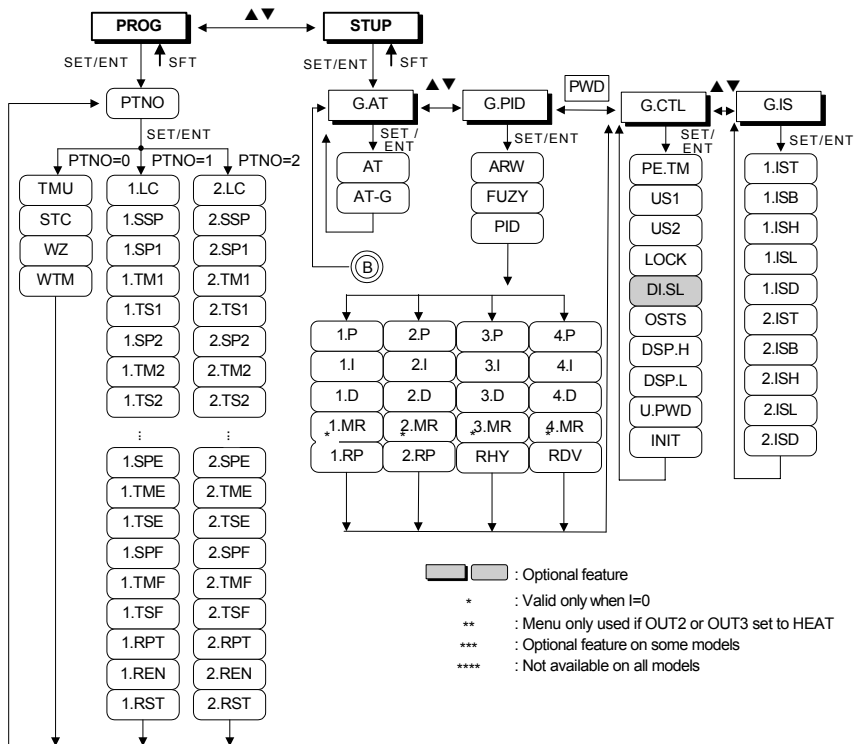

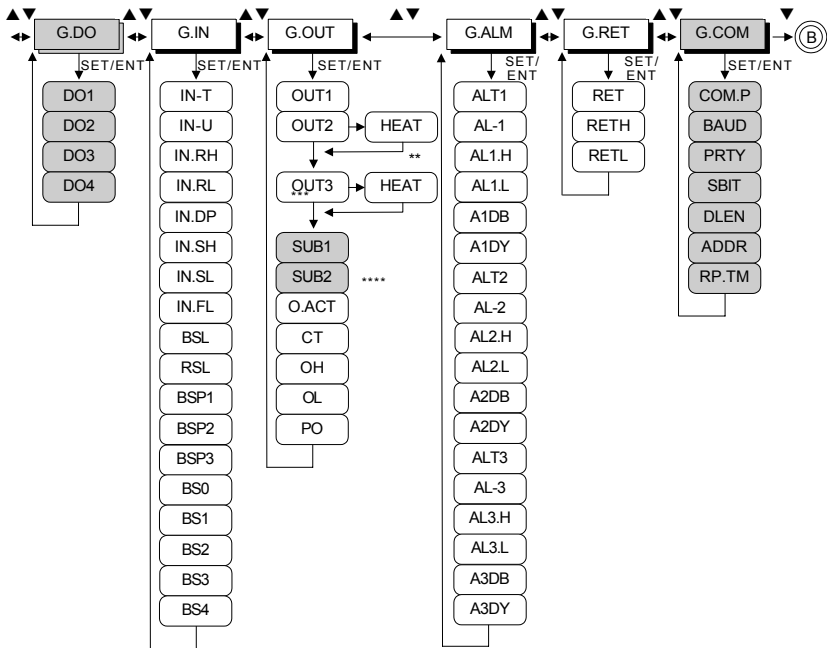

4. Operation Flow Chart

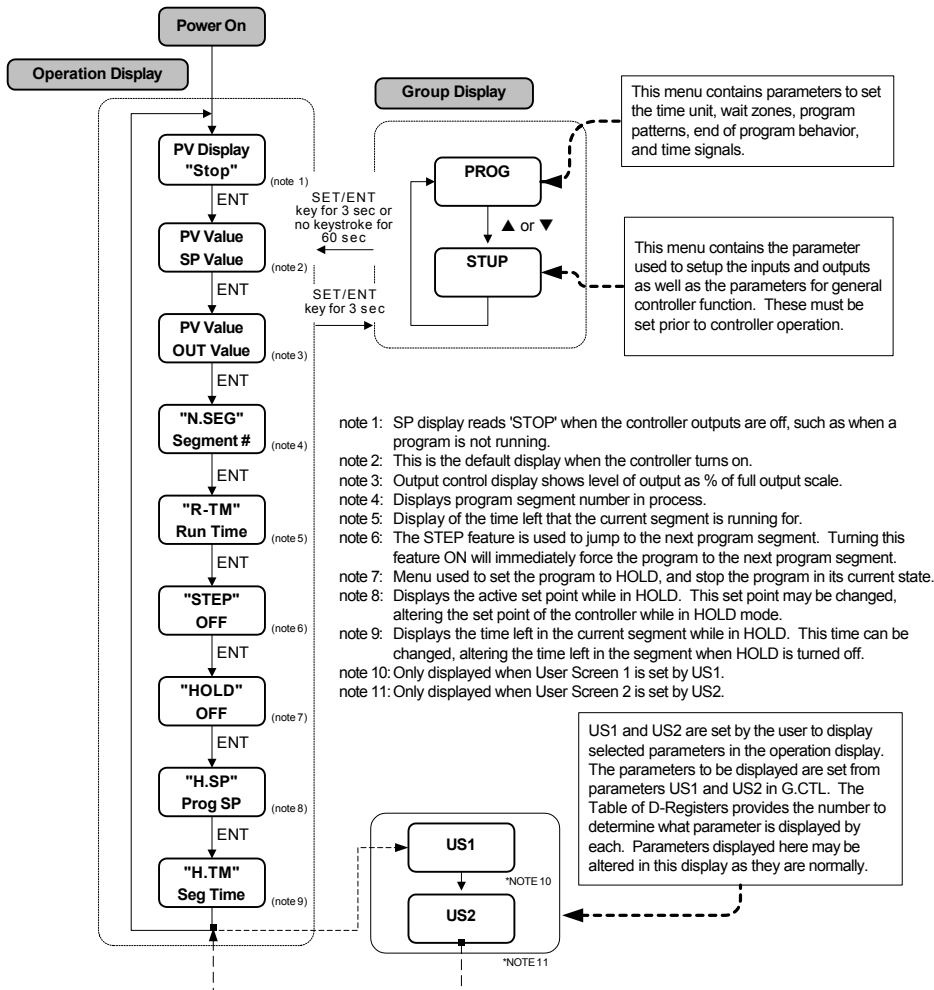

5. Controller Parameter Setup

5.1 Input Group (G.IN)

PV G In

Press SET/ENT key to select input group. Press press ▲ or ▼ key to cycle through groups as shown below. (Refer to parameter map in section 3.)

```

      ▲▼   ▲▼   ▲▼   ▲▼   ▲▼   ▲▼
      G.AT ↔ G.PID ↔ PWD ↔ G.CTL ↔ G.IS ↔ G.DO
      ▲   ▲   ▲   ▲   ▲   ▲
      ↑   ↑   ↑   ↑   ↑   ↑
      G.COM ↔ G.RET ↔ G.ALM ↔ G.OUT ↔ G.IN
      ▲▼   ▲▼   ▲▼   ▲▼   ▲▼
          
```



Input group parameters should be established first, as changes to the input type may reset other parameter settings in other groups to their default value.







PV In-t

This parameter selects the type of input sensor used. Its default setting is type TC.K1. Refer to the following table showing the type of sensor inputs and select the desired input type.

Table 1: Universal Input Selection

display range : -5% to 105%

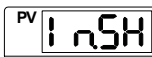
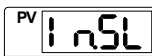
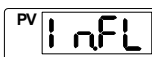
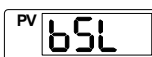
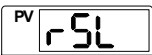
No.	TYPE	Temp.Range (°C)	Temp.Range (°F)	Group	DISP
1	K1	-200 to 1370	-300 to 2500	Thermocouple	TC.K1
2	K2	-199.9 to 999.9	0 to 2300		TC.K2
3	J	-199.9 to 999.9	-300 to 2300		TC.J
4	E	-199.9 to 999.9	-300 to 1800		TC.E
5	T	-199.9 to 400.0	-300 to 750		TC.T
6	R	0 to 1700	32 to 3100		TC.R
7	B	0 to 1800	32 to 3300		TC.B
8	S	0 to 1700	32 to 3100		TC.S
9	L	-199.9 to 900.0	-300 to 1600		TC.L
10	N	-200 to 1300	-300 to 2400		TC.N
11	U	-199.9 to 400.0	-300 to 750		TC.U
12	W	0 to 2300	32 to 4200		TC.W
13	Platinel II	0 to 1390	32 to 2500		TC.PL
14	PIA	-199.9 to 850.0	-300 to 1560	RTD (0.00385)	PTA
15	PIB	-199.9 to 500.0	-199.9 to 999.9		PTB
16	PIC	-19.99 to 99.99	-4.0 to 212.0		PTC
17	JPIA	-199.9 to 500.0	-199.9 to 999.9	RTD (0.00392)	JPTA
18	JPIB	-150.0 to 150.0	-199.9 to 300.0		JPTB
19	0.4 to 2.0V	0.400 to 2.000V		VDC	2V
20	1 to 5V	1.000 to 5.000V			5V
21	0 to 10V	0.00 to 10.00V			10V
22	-10 to 20mV	-10.00 to 20.00mV		mVDC	20M
23	0 to 100mV	0.0 to 100.0mV			100M

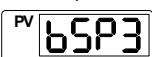
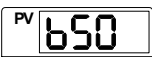
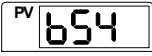
	<p>This parameter sets the display temperature unit for °C or °F. Its default selection is °C. Refer to Table 1 when changing the temperature unit for the temperature input range.</p>
	<p>This parameter sets the high limit of the temperature display range (maximum temperature displayed). For mV and V inputs, this sets the value of the high input of the input scale defined in In.SH.</p>
	<p>This parameter sets the low limit of the temperature display range (minimum temperature displayed). For mV and V inputs, this sets the low input of the input scale defined in In.SL.</p>
	<p>This parameter sets the position of the decimal point for mV or V inputs. The position of the decimal point can be set as 9999, 999.9, 99.99, or 9.999. Its default set value is 1.</p>
	<p>The parameter to set the high limit of the mV or V display scale. This value will be displayed when the input is set to the high input established in In.r.H. Its default value is 100.0.</p>
	<p>The parameter to set the low limit of the mV or V display scale. This value will be displayed when the input is set to the low input established in In.r.L. Its default value is 0.0.</p>
	<p>The parameter to set the PV filter for stabilization from electromagnetic noise and interference. This will effect the rate of change in the PV display value. Its default setting is OFF, and can be set within 1 to 120 seconds.</p>
	<p>This parameter to establishes PV behavior when an open input sensor is detected. When BSL is set to UP, the PV operates as if at the high input range. When BSL is set to DOWN, the PV operates as if at the low input range. Its default setting is UP. In the case of mV or V inputs, the default setting is OFF. An open sensor check is not performed in 10 V, 20 mV, or 100 mV input settings.</p>
	<p>This parameter determines if RJC for thermocouple inputs is used. RJC can be turned on or off. Its default setting is ON.</p>
 <p style="text-align: center;">⋮</p> 	<p>This parameter sets where the PV bias points occur. See Fig 1 and Fig 2 for further information about input bias operation.</p>
 <p style="text-align: center;">⋮</p> 	<p>This parameter sets the bias value at the corresponding bias point input values. These parameters establish the value of the offset at each of the defined BSP1 - BSP3 points. See Fig 1 and Fig 2 for further information about input bias operation.</p>

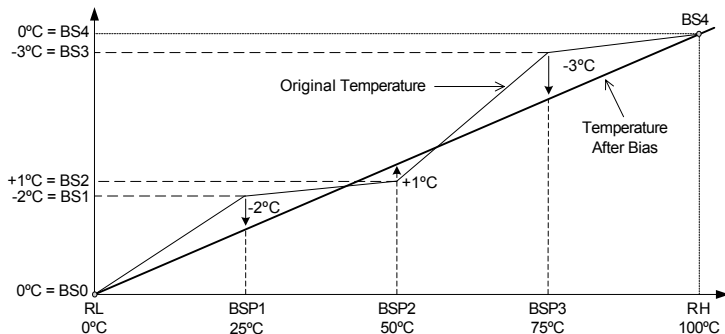

Fig 1: Temperature Bias

Example 1: The original temperature is shown within the range of 0°C (Range Low) and 100°C (Range High). Bias points have been used to adjust the displayed temperature as shown in the graph in Fig 1.

To establish this bias, the settings are shown below.

Temperature Settings to Establish Where the Bias Occurs				
RL	BSP1	BSP2	BSP3	RH
0°C	25°C	50°C	75°C	100°C
Bias Offset for Each Point				
BS0	BS1	BS2	BS3	BS4
0°C	-2°C	+1°C	-3°C	0°C

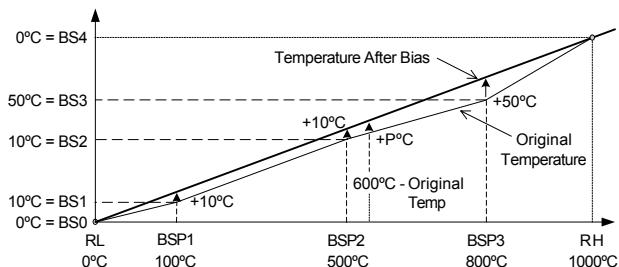

Fig 2: Bias Formula Calculation

Example 2: Temperature Bias Value (BS0 through BS4) = Temperature After Bias - Actual Temperature
 Display temperature after bias at 600°C actual temperature = P

$$P = 600 + (600 - BPS2) \times \frac{BS3 - BS2}{BSP3 - BSP2} + BS2$$

$$P = 600 + (600 - 500) \times \frac{50 - 10}{800 - 500} + 10 = 623^\circ\text{C Temperature After Bias}$$

Input Group Parameter Summary

Display	Parameter	Setting Range	Unit	Default	Remark
IN-T	Input Type	Refer to Table 1: Universal Input Selection	ABS	TC.K1	
IN-U	Display Unit	°C / °F	ABS	°C	T/C, RTD
IN.RH	Max PV Display Range	Within sensor input range Refer to Table 1 INRH > INRL	AEU	1370	
IN.RL	Min PV Display Range		AEU	-200	
IN.DP	Decimal Point Position	0, 1, 2, or 3	ABS	1	mV, V
IN.SH	Max Input Value Scale	-1999 to 9999 INSH > INSL Decimal position determined by IN.DP	ABS	100.0	mV, V
IN.SL	Min Input Value Scale		ABS	0.0	mV, V
IN.FL	PV Filter	OFF, 1 to 120	sec	OFF	
BSL	Open Sensor Behavior	OFF, UP, DOWN	ABS	UP	Not Used for VDC Input
RSL	RJC Operation	ON, OFF	ABS	ON	Only Used for TC Input
BSP1	Reference Bias Point 1	AEU (0.0 to 100.0%), RL<BSP1<BSP2<BSP3<RH	AEU	AEU (100.0%)	
BSP2	Reference Bias Point 2	AEU (0.0 to 100.0%), RL<BSP1<BSP2<BSP3<RH	AEU	AEU (100.0%)	
BSP3	Reference Bias Point 3	AEU (0.0 to 100.0%), RL<BSP1<BSP2<BSP3<RH	AEU	AEU (100.0%)	
BS0	Bias Value for RL Point	GEU (-100.0 to 100.0%)	GEU	0	
BS1	Bias Value at BSP1	GEU (-100.0 to 100.0%)	GEU	0	
BS2	Bias Value at BSP2	GEU (-100.0 to 100.0%)	GEU	0	
BS3	Bias Value at BSP3	GEU (-100.0 to 100.0%)	GEU	0	
BS4	Bias Value at RH	GEU (-100.0 to 100.0%)	GEU	0	





There are two types of engineering units values used in the setting of parameters, absolute engineering units (AEU) and general engineering units (GEU). An AEU parameter is set using an absolute value engineering unit that represents a specific point, such as a specific temperature or voltage level. An GEU parameter is set using engineering units, however it is a general value, and not tied to any input or output level.

For example: When establishing input bias, parameter BSP1 sets the specific PV value where bias point one will occur. This parameter has a unit designation of AEU. BS1, the amount of offset at BSP1 is set in engineering units, however this parameter occurs at whatever BSP1 is set to, and therefore does not have an absolute setting related to any input or output, it is just the amount of offset at where BSP1 occurs. While one is related to an absolute input value, and the other stand alone value, both are set as engineering units, such as BSP1 set as 100°C and BS1 set as 3°C.

5.2 Output Group (G.OUT)

	<p>Press SET/ENT key to select input group. (Refer to parameter map in section 3.)</p> <p style="text-align: center;"> ▲▼ G.AT ↔ G.PID ↔ PWD ↔ G.CTL ↔ G.IS ↔ G.DO ▲▼ G.COM ↔ G.RET ↔ G.ALM ↔ <u>G.OUT</u> ↔ G.IN ▲▼ ▲▼ ▲▼ ▲▼ ▲▼ </p>
---	---

	<p>This parameter sets the type of operation for output 1. (OUT1: relay output) The output can be set to HEAT (PID Control), ALM1, ALM2, ALM3, RUN, IS1, IS2, TS, or PEND. Its default setting is ALM1. See Notes below.</p>
---	--

	<p>This parameter establishes the type of operation for output 2. (OUT2: 4-20 mA or voltage pulse) This output can be set for HEAT (PID Control) or RET (Retransmitting). Its default setting is HEAT.</p>
---	--

	<p>This parameter establishes the type of operation for output 2. (OUT3: 4-20 mA or voltage pulse) This output can be set for HEAT (PID control) or RET (retransmitting). Its default setting is HEAT. Menu appears only on models with the OUT3 output.</p>
---	--

	<p>This parameter selects the type of output signal for each analog output (OUT2 and OUT3) when they are set to HEAT. The outputs can be set to SSR (pulse output) or SCR (4-20 mA). Its default setting is SSR.</p>
---	--

	<p>This parameter sets the type of operation for auxiliary output 1 (SUB1: relay output) Output can be set to HEAT, ALM1, ALM2, ALM3, RUN, IS1, IS2, TS, or PEND. Its default setting is ALM2. Menu appears only on models with the SUB1 output option.</p>
---	---

	<p>This parameter sets the type of operation for auxiliary output 1 (SUB2: relay output) Output can be set to HEAT, ALM1, ALM2, ALM3, RUN, IS1, IS2, TS, or PEND. Its default setting is ALM2. Menu appears only on models with the SUB2 output option.</p>
---	---

NOTE Output Operation Settings:
HEAT is used to set the output for PID control, as time-proportional control for relay outputs or 4-20 mA or voltage pulse outputs for analog outputs. RUN will set the relays to always on. If set for TS (time signal) the relays will trigger if the time signal is on for the current program segment (see 1.TS1 under PROG menu). PEND will trigger relay outputs after the program cycle ends for the time set in PE.TM under G.CTL. For additional information on the setup of ALM1, ALM2, ALM3 (alarm), IS1, and IS2 (inner signal) refer to G.ALM and G.IS.

NOTE Output Group Menu Progression Example:
The following settings establish relay output 1 (OUT1) to trigger based on alarm 1, for analog output 2 (OUT2) to operate as a heating temperature controller outputting a voltage pulse, for analog output 3 (OUT 3) to output a retransmitting 4-20 mA signal, and for auxiliary relay outputs SUB1 and SUB2 to trigger with alarm 2 and alarm 3.

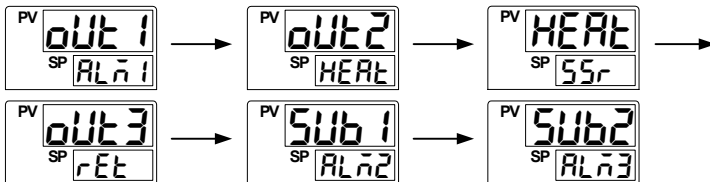

	<p>This parameter establishes reverse (REV) or forward (FWD) activation of the control outputs. In forward operation, the control outputs will be most active when the PV value is higher than the SP, as the controller acts to lower the PV. In reverse operation, the control outputs will be most active when the PV value is lower than the SP value, as the controller acts to increase the PV. The default setting is REV.</p>
	<p>This parameter establishes the cycle time for use with time-proportional PID relay or voltage pulse control when the outputs are set to HEAT or COOL. The cycle time can be set from 1 to 300 seconds. Its default setting is 2 seconds.</p>

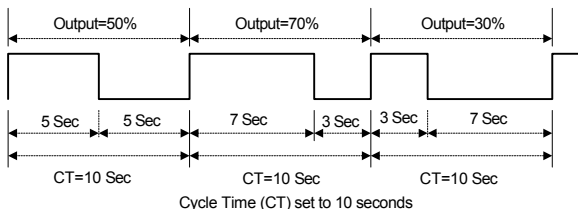

Fig 3: Time-Proportional PID Control Output

	<p>This parameter sets a high limit for the levels of the control output. This limits the output levels based on a percentage of their full scale. Its default setting is 100 (%).</p>
	<p>This parameter sets a low limit for the levels of the control output. This prevents the outputs from dropping below a certain level based on a percentage of their full scale. Its default setting is 0 (%). The outputs are limited by both the the low and high limits.</p>
	<p>This parameter establishes a specific output value for use in emergency conditions. This percentage level for the control outputs will be set after a PID algorithm error, A/D error, or open sensor error is detected.</p>

Output Group Parameter Summary

Display	Parameter	Setting Range	Unit	Default	Remark
OUT1	Select Output	HEAT, ALM1, ALM2, ALM3, IS1, IS2, TS, PEND	ABS	ALM1	
OUT2	Select Output	HEAT, RET	ABS	HEAT	
OUT3	Select Output	HEAT, RET	ABS	RET	Models with OUT3 Only
HEAT	Select Output Type	SSR, SCR	ABS	SSR	When OUT2 or 3 is Set to HEAT
SUB1	Select Output	HEAT, ALM1, ALM2, ALM3, IS1, IS2, TS, PEND	ABS	ALM2	Option
SUB2	Select Output	HEAT, ALM1, ALM2, ALM3, IS1, IS2, TS, PEND	ABS	ALM3	Option
O.ACT	Reverse and Forward	REV, FWD	ABS	REV	
CT	Cycle Time 1	1 to 300 seconds	sec	2 sec	
OH	High Limit of Output	OL + 1 digit to 105.0% OH>OL	%	100.0%	
OL	Low Limit of Output	-5.0% to OH setting OH>OL	%	0%	
PO	Preset Output	-5.0 to 105.0%	%	0.0%	

5.3 Control Group (G.CTL)









	<p>Press SET/ENT key to select control group. (Refer to parameter map in section 3.)</p>
	
	<p>This parameter establishes how long after a program ends the relay outputs will trigger for if set to PEND. Its default setting is 15 seconds. This parameter is always set in seconds.</p>
 	<p>This parameter establishes the user screens for viewing, confirmation, and setup of commonly used parameters from the operation display. To add the parameter to the operation display, enter the corresponding number for the parameter from the Table of D-Registers as either US1 or US2. The default settings are OFF.</p> <p>➔ See page 14 and the Operation Flow Chart for a map of the operation display.</p>
	<p>Turning ON this parameter locks all settings from being changed. This applies to the operation display functions, such as changing the set point, as well as setting group parameters. If ON, only the LOCK parameter may be changed. The default setting is OFF.</p>
	<p>This parameter establishes the operation of the digital input (DI) external contacts. The digital input operating configurations are shown in Table 2: DI Operation. This feature is only valid for models with digital inputs.</p>

Table 2: DI Operation

DI.SL	DI1	DI2	Operation
OFF	-	-	DI Disabled
1	off	-	HOLD OFF
	on	-	HOLD ON
	-	off	STEP OFF
	-	on	STEP ON
2	off	-	RESET
	on	-	PROG RUN
	-	off	PROG1
	-	on	PROG2

	<p>When this parameter is on, the output settings will be displayed in the operation display. The settings of parameters OUT1, OUT2, OUT3, SUB1, and SUB2 will be shown. Only outputs built into the model being used will display. Its default setting is OFF.</p>
	<p>This parameter sets the high limit of the sensor input in the PV display. The PV value will not display higher than this limit, however the control functions will operate based on the actual input value.</p>
	<p>This parameter sets the low limit of the sensor input in the PV display. The PV value will not display lower than this limit, however the control functions will operate based on the actual input value.</p>
	<p>This parameter establishes the password for the controller. This password must be entered at the PWD screen before accessing the control group (G.CTL) or it will not access the setting groups after the PWD prompt. The default setting is "0". See the parameter map in section 3 for the location of the PWD prompt in the group menus.</p>

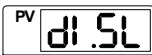
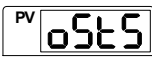
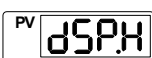

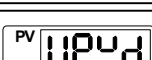
Be sure not to forget the password once it has been set. If the password is forgotten, contact technical support as listed on the back of this manual.

	<p>This parameter resets the parameters to their factory settings. To reset the controller, set this parameter to ON. After reset, it will return to the OFF setting.</p>
---	---



Most parameters will be reset to their default settings when the controller is initialized. Note the current settings before this is done so they can easily be restored after controller initialization.

Control Group Parameter Summary

Display	Parameter	Setting Range	Unit	Default	Remark
PE.TM	Pattern End Alarm Time	OFF, 1 to 9999 sec seconds	ABS	15 (sec)	
US1	User Screen	OFF, D-Register Number 1 to 1299	ABS	OFF	
US2	User Screen	OFF, D-Register Number 1 to 1299	ABS	OFF	
LOCK	Parameter Lock	OFF, ON (No Editing)	ABS	OFF	
DI.SL	DI Selection	OFF, 1, 2	ABS	OFF	DI Option
OSTS	Output Status Display	OFF, ON	ABS	OFF	
DSP.H	Display High Limit	AEU (-5.0 to 105.0%), DSP.L<DSP.H	AEU	AEU (105.0%)	
DSP.L	Display Low Limit	AEU (-5.0 to 105.0%), DSP.L<DSP.H	AEU	AEU (-5.0%)	
U.P.W.D	User password	0 to 9999	ABS	0	
INIT	Factory Initialization	OFF, ON	ABS	OFF	

5.4 Program Group (G.PROG)

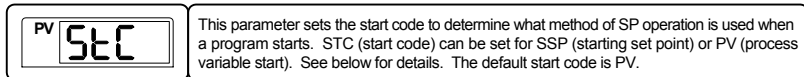
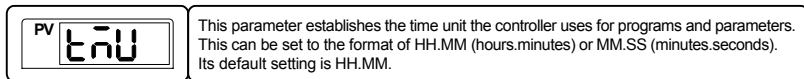
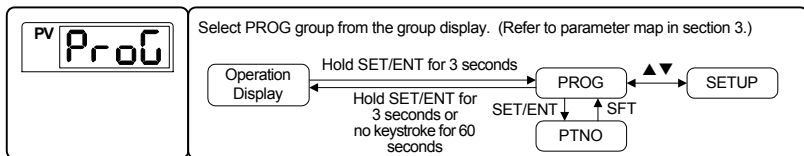

STC Operation

SSP START (STC set to SSP)

In Start Set Point mode, the program will begin with at the default set point set in the program (SSP) and ramp to the set point value for segment 1 (SP1) over the time designated in time segment 1 (TM1).

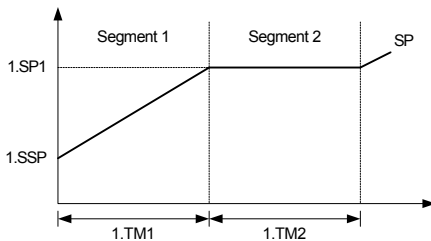

Fig 4: Start Code SSP Start

For a soak segment, the set point for the segment is the same as the set point prior to the soak segment. In this case, the program will hold the set point at that value for the length of the segment. In the above example, 1.SP1 and 1.SP2 are the same, and the set point is steady for the time indicated in 1.TM2.

PV Start (STC set to PV)

In PV mode, the program will immediately start at the point in the program where the set point is equal to the PV value when the program starts running. In the case where the PV is beyond any set point in the program, the program will immediately start at beginning of the first soak segment. If no soak segment is present in the program, it will start at the point closest to the PV.

If the starting point of the program, based on the PV at the start of the program, would occur during a ramp segment, the program will recalculate the time left in the ramp segment. The rate of set point change in the ramp will remain the same, and the program will calculate how much time remains in that segment based on the original rate of change characteristics from the set point of the last segment to the SP of the ramp segment. Refer to the graphics on the following pages for additional information.

STC set to PV, first soak at segment 2

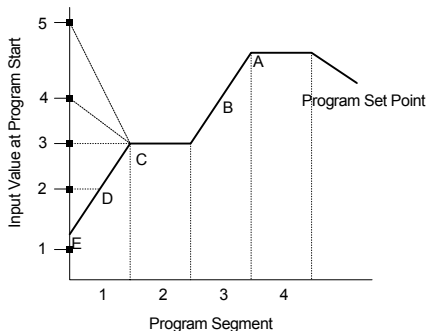

Starting PV At Program Activation	Immediate Program Start Point
5	C
4	C
3	C
2	D
1	E (SSP)

STC set to PV, first soak at segment 3

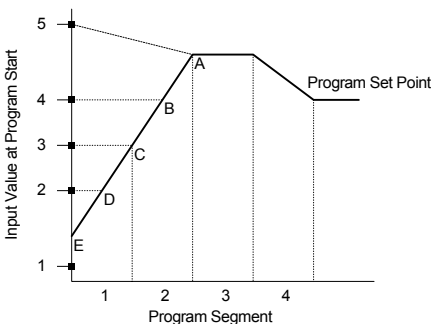

Starting PV At Program Activation	Immediate Program Start Point
5	A
4	B
3	C
2	D
1	E (SSP)

STC set to PV, with no soak segment in the program

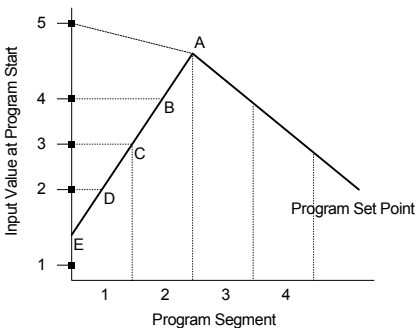

Starting PV At Program Activation	Immediate Program Start Point
5	A
4	B
3	C
2	D
1	E (SSP)

STC set to PV, with only ascending ramp segments

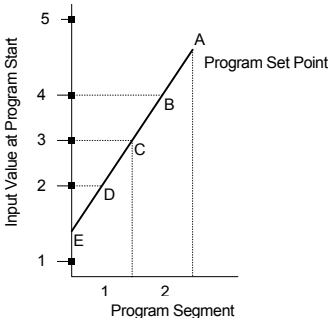

Starting PV At Program Activation	Immediate Program Start Point
5	Program Will Not Start
4	B
3	C
2	D
1	E(SSP)

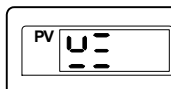

This parameter establishes the wait zone range. This sets the deviation value used for the wait function. When set, a running program will not move to the next segment until the PV enters the wait zone, or the wait time has passed. When OFF, the wait function will not be enabled. See Fig 5 for more information about this process.

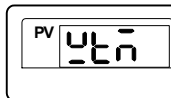

This is the wait time parameter, which sets the time the program will wait for the PV to enter the wait zone before starting the next program segment. The setting range is OFF (0) to 99.59 (time units set by TMU). When OFF, the wait function will not be enabled. See Fig 6 for more information.

NOTE Wait Function

The wait function delays the start of the next program segment until the PV reaches within a specified deviation range from the SP, or until the wait time has expired. The wait zone defines the deviation range the PV must reach to activate the next segment, and the wait time establishes a limit on how long the program will wait before activating the next segment.

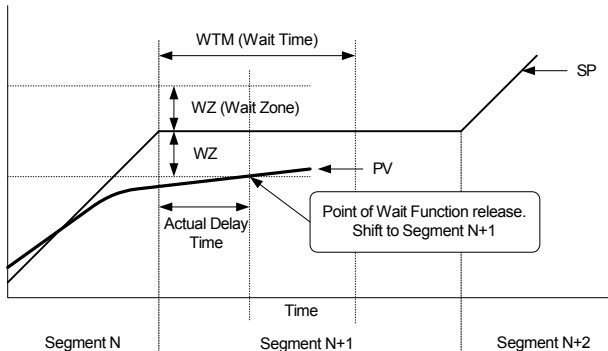

Fig 5: Wait Function Wait Zone Release

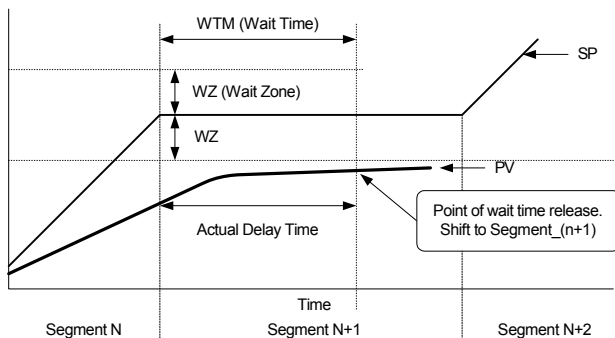

Fig 6: Wait Function Wait Time Release

PV **LLC**

The link parameter establishes the operation of the controller when a program has finished running. The link codes that determine the controller operation when a program ends are shown in Table 3 below.

Table 3: Link Codes

Link Code	Controller Operation When a Program is Complete
RST	Shift to RESET (Stop) (All operation stops)
HOLD	Continues to run at the last set point (Will enter STOP mode when RST key pressed)
PTN1	Runs PTN1 (Program 1) (Program 1 will infinitely repeat if set in 1.LC)
PTN2	Runs PTN2 (Program 2) (Program 2 will infinitely repeat if set in 2.LC)

PV **1SSP**

This parameter sets the starting set point for program 1. This set point is used when the program is set for a STC of SSP, or to calculate the ramp time for segment 1 if needed when STC is set to PV.

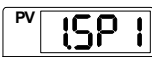
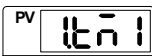
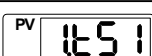
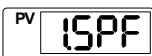
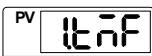
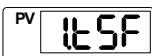
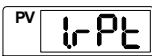
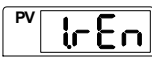
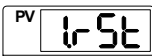
	<p>This parameter sets the target set point (TSP) for program segment 1. The parameter is set in the same way for segments 1 to 15 (1.SP1 to 1.SPF).</p>
	<p>This parameter sets the running time for the segment. This can be set as OFF or 1 to 99.59 (time unit set in TMU). In the case of an OFF setting, the program will stop running after the previous segment. This parameter is set in the same way for segments 1 to 15 (1.TM1 to 1.TMF).</p>
	<p>This parameter determines if the status of time signal (TS) relay outputs are ON or OFF for the duration of the program segment. This parameter is set in the same way for segments 1 to 15 (1.TS1 to 1.TSF).</p>
<p>⋮</p>	
	<p>This parameter sets the target set point (TSP) for program segment 15.</p>
	<p>This parameter sets the running time for segment 15. This can be set as OFF or 1 to 99.59 (time unit set in TMU). In the case of an OFF setting, the program will stop running after the previous segment.</p>
	<p>This parameter determines if the status of time signal (TS) relay outputs are ON or OFF for the duration of program segment 15.</p>
	<p>This repeat parameter allows segments set with 1.REN and 1.RST to be repeated during the program. This setting is the number of times the repeated segments will be used in the program. If set as 0, the repeated segments will repeat infinitely. The default setting is 1.</p>
	<p>This parameter establishes the repeat end segment. This is the last segment that will be repeated. After this segment, the program will cycle back to the segment defined in 1.RST. The repeated segments will appear a number of times as defined in 1.RPT.</p>
	<p>This parameter establishes the repeat start segment. This is the first segment that will be repeated. If the program is set to repeat, after the segment defined in 1.REN the program will loop back to the segment defined by this parameter.</p>
<p>⋮</p>	
<p>The parameters used to set up program 2 are the same as those used for program 1.</p>	



NOTE

Reminder: If a program requires less than the 15 segments possible, set the running time for the segment after the last segment needed to OFF, and only the segments prior to that segment will be used. For example, to use only 5 segments, set 1.TM6 to OFF.

Program Group Parameter Summary

Display	Parameter	Setting Range	Unit	Default	Remark
TMU	Time Unit	HH.MM, MM.SS	ABS	HH.MM	
STC	Start Code	SSP, PV	ABS	PV	
WZ	Wait Zone	OFF (0), GEU (0.0% +1 digit to 00.0%)	GEU	OFF (0)	
WTM	Wait Time	OFF (0.00) to 99.59	TIME	OFF (0.00)	
n.LC	Link Code	RST, HOLD, PTN1, PTN2	ABS	RST	
n.SSP	Program Start SP	AEU (0.0 to 100.0%)	AEU	AEU (0.0%)	
n.SP1	Target SP 1	AEU (0.0 to 100.0%)	AEU	AEU (0.0%)	
n.TM1	Segment Time 1	OFF, 0.00 to 99.59	TIME	OFF	
n.TS1	Time Signal 1 On/Off	ON, OFF	ABS	OFF	
n.SP2	Target SP 2	AEU (0.0 to 100.0%)	AEU	AEU (0.0%)	
n.TM2	Segment Time 2	Time Set : OFF, 0.00 to 99.59	TIME	OFF	
n.TS2	Time Signal 2 On/Off	ON, OFF	ABS	OFF	
⋮	⋮	⋮	⋮	⋮	⋮
n.SP15	Target SP 15	AEU (0.0 to 100.0%)	AEU	AEU (0.0%)	
n.TM15	Segment Time 15	OFF (0), 0.00 to 99.59	TIME	OFF	
n.TS15	Time Signal 15 On/Off	ON, OFF	ABS	OFF	
n.RPT	Segment Repeat	0 to 999 (0 : Infinite Repeat)	ABS	1	
n.REN	Repeat End Segment	$0, 1 \leq RST \leq n.REN \leq 15(F)$	ABS	0	
n.RST	Repeat Start Segment	$0, 1 < RST < n.REN < 15(F)$	ABS	0	

5.5 Digital Output Group (G.DO)

 Digital Outputs are an optional feature. These parameters are only used when appropriate for a controller with 2 or 4 digital outputs as an optional feature

NOTE







	<p>Press SET/ENT key to select the digital output group. (Refer to parameter map)</p> <p style="text-align: center;">  </p>
	<p>This parameter establishes the function of digital output 1 (DO1). This function sets what conditions will activate the output. The settings and functions that can be selected are shown in Table 4 below.</p>
	<p>This parameter establishes the function of digital output 2 (DO2). This function sets what conditions will activate the output. The settings and functions that can be selected are shown in Table 4 below.</p>
	<p>This parameter establishes the function of digital output 3 (DO3). This function sets what conditions will activate the output. The settings and functions that can be selected are shown in Table 4 below.</p>
	<p>This parameter establishes the function of digital output 4 (DO4). This function sets what conditions will activate the output. The settings and functions that can be selected are shown in Table 4 below.</p>

Table 4 : DO Settings and Functions

DO Setting	Function	DO Setting	Function
ALM1	Alarm 1	PEND	Activate when a program ends
ALM2	Alarm 2	UP	Activate during an ascending ramp segment
ALM3	Alarm 3	DOWN	Activate during a descending ramp segment
IS1	Inner Signal 1	SOAK	Activate during an soak segment
IS2	Inner Signal 2	RUN	Activate when a program is running
TS	Segment Time Signal		

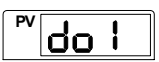
Digital Output Group Parameter Summary

Display	Parameter	Setting Range	Unit	Default	Remark
DO1	DO1 Type	ALM1, ALM2, ALM3, IS1, IS2, TS, PEND, UP, DOWN, SOAK, RUN	ABS	OFF	Option
DO2	DO2 Type	ALM1, ALM2, ALM3, IS1, IS2, TS, PEND, UP, DOWN, SOAK, RUN	ABS	OFF	Option
DO3	DO3 Type	ALM1, ALM2, ALM3, IS1, IS2, TS, PEND, UP, DOWN, SOAK, RUN	ABS	OFF	Option
DO4	DO4 Type	ALM1, ALM2, ALM3, IS1, IS2, TS, PEND, UP, DOWN, SOAK, RUN	ABS	OFF	Option

5.6 Inner Signal Group (G.IS)

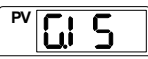
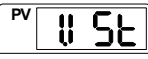
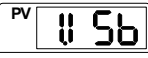
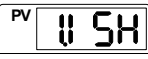
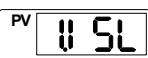
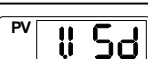
	<p>Press SET/ENT key to select the inner signal group. (Refer to parameter map)</p> <p style="text-align: center;"> ▲▼ G.AT ↔ ▲▼ G.PID ↔ ▲▼ PWD ↔ ▲▼ G.CTL ↔ ▲▼ <u>G.IS</u> ↔ ▲▼ G.DO ▲▼ ↑ ▲▼ G.COM ↔ ▲▼ G.RET ↔ ▲▼ G.ALM ↔ ▲▼ G.OUT ↔ ▲▼ G.IN ▲▼ ↓ ▲▼ </p>
	<p>The parameter to set the basis of inner signal activation. The settings are NPV (current value of the PV), NSP (current value of the SP), or TSP (target set point of the current program segment). Its default setting is NPV.</p>
	<p>This parameter sets the inner signal activation zone to be inside or outside the IS band. When the value set in 1.ISB enters the inner signal zone, outputs set to inner signal 1 will activate. The settings are I.BD (in band) and O.BD (out band) where the bands are determined by the values in 1.ISH and 1.ISL (See Fig 7).</p>
	<p>The parameter to establish the high value for the setup of the inner signal band.</p>
	<p>The parameter to establish the low value for the setup of the inner signal band.</p>
	<p>The parameter to set the inner signal delay. This is the delay time from when the inner signal activation conditions are met to when the outputs activate.</p>
<p>...</p>	<p>The parameters used to setup inner signal 2 is the same as those used for inner signal 1.</p>

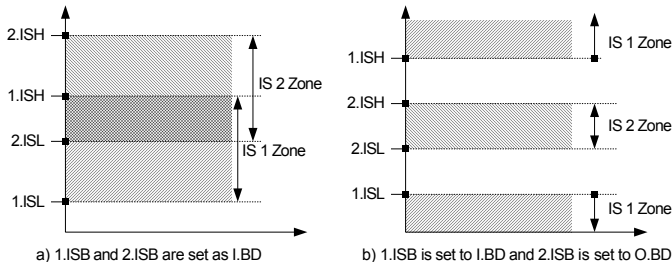

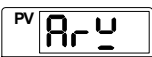



Fig 7: Inner Signal Zones

Inner Signal Group Parameter Summary

Display	Parameter	Setting Range	Unit	Default	Remark
1.IST	Inner Signal Type	NPV, NSP, TSP	ABS	NPV	
1.ISB	Inner Signal Band Direction	I.BD (In Band), O.BD (Out Band)	ABS	I.BD	
1.ISH	Inner Signal Range High 1	AEU (0.0 to 100.0%), but 1.ISH \geq 1.ISL	AEU	AEU (0.0%)	
1.ISL	Inner Signal Range Low 1	AEU (0.0 to 100.0%), but 1.ISH \geq 1.ISL	AEU	AEU (0.0%)	
1.ISD	Inner Signal Delay Time	OFF (00.00) to 99.59 (MM.SS)	TIME	OFF	
2.IST	Inner Signal Type	NPV, NSP, TSP	ABS	NPV	
2.ISB	Inner Signal Band Direction	I.BD (In Band), O.BD (Out Band)	ABS	I.BD	
2.ISH	Inner Signal Range High 2	AEU (0.0 to 100.0%), but 2.ISH \geq 2.ISL	AEU	AEU (0.0%)	
2.ISL	Inner Signal Range Low 2	AEU (0.0 to 100.0%), but 2.ISH $>$ 2.ISL	AEU	AEU (0.0%)	
2.ISD	Inner Signal Delay Time	OFF (00.00) to 99.59 (MM.SS)	TIME	OFF	

5.7 PID Group (G.PID)

	<p>Press SET/ENT Key to select PID Group after press jã or jâ Key in Menu display</p> <p style="text-align: center;"> G.AT ↔ <u>G.PID</u> ↔ PWD ↔ G.CTL ↔ G.IS ↔ G.DO ↑ G.COM ↔ G.RET ↔ G.ALM ↔ G.OUT ↔ G.IN ↓ </p>
	<p>The parameter sets the PV deviation width to prevent overshoot. When the control outputs reach this high limit value, they stop ordinary output action for integral control and use ARW (Anti-Reset Windup). When the setting is AUTO, this parameter is calculated automatically.</p>
	<p>This parameter activates the use of fuzzy logic. Fuzzy logic can be effective in suppressing overshoot and reducing PV variation that may occur once the PV has reached the SP. Refer to Fig 5: Overshoot Suppression with Fuzzy Logic.</p>

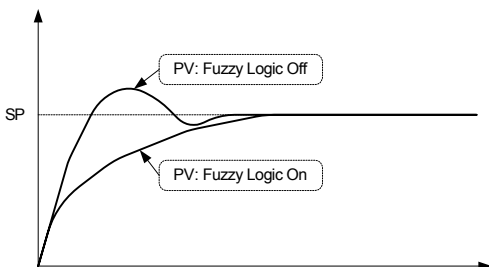
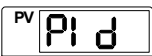

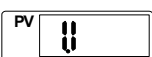
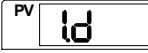
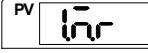
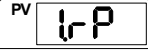
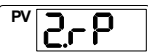
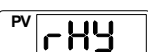
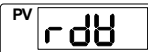



Fig 8: Overshoot Suppression with Fuzzy Logic

	<p>This parameter establishes the number of PID setting groups to be used in control output calculation. Up to 4 user defined groups of proportional, integral, and derivative value zones can be established. Use this setting to enter the setting menus for each PID group.</p>
	<p>The parameter to set the proportional operation for PID control. Setting range of 1.P is 0.1 to 999.9%. Its default setting is 10.0%.</p>
	<p>The parameter to set the integration time for PID control. Setting ranges of 1.I are OFF or 1 to 6000 seconds. Its default setting is 120 seconds</p>

PV 	The parameter to set derivation time for PID control. Setting ranges of 1.D are OFF or 1 to 6000 seconds. Its default setting is 30 seconds.
PV 	The parameter to set the manual reset in the PID calculation. This setting only functions if the integral time setting is OFF. This setting always functions for H/C models.
Note: The contents of PID Groups 2, 3, and 4 are the same as PID Group 1.	
PV 	This parameter establishes the PV range of each of the 3 main PID zones. The range of PID zone 1 is IN.RL (IN.SL if set for mV or V input) to 1.RP. The range of PID zone 2 is 1.RP to 2.RP. The range of PID zone 3 is 2.RP to IN.RH (IN.SH if set for mV or V input).
PV 	This parameter establishes the range of each of the 3 main PID zones. The range of PID zone 1 is IN.RL (IN.SL if set for mV or V input) to 1.RP. The range of PID zone 2 is 1.RP to 2.RP. The range of PID zone 3 is 2.RP to IN.RH (IN.SH if set for mV or V input).
PV 	This parameter establishes the hysteresis width of the PID zone.
PV 	This parameter sets the range of deviation for PID zone 4. When the difference between the PV and SP is greater than this deviation range, the controller will utilize PID group 4 for PID settings. While the PV and SP are within this deviation difference, the controller will utilize whatever zone would normally be used based on the PV value.

Display	Parameter	Setting Range	Unit	Default	Remark
ARW	Anti-Reset Wind-Up Select	Auto or 50.0 to 200.0%	%	Auto	
FUZY	Fuzzy	OFF, ON	ABS	OFF	
PID	PID Number	MENU (0) or 1, 2, 3 or 4	ABS	MENU	
n.P	n.Proportional	0.1 to 999.9%	%	10.0%	
n.I	n.Pro/Time	OFF, 1 to 6000 sec	sec	120 sec	
n.D	n.Derivation time	OFF, 1 to 6000 sec	sec	30 sec	
n.MR	n.Manual Reset	-5.0 to 105.0%	%	50.0%	For Use When I=0
1.RP	Reference Point 1	AEU (0.0%), 1.RP ≤ 2.RP	AEU	AEU (100.0%)	PID Zone 1
2.RP	Reference Point 2	1.RP ≤ 2.RP ≤ AEU (100.0%)	AEU	AEU (100.0%)	PID Zone 2
RHY	Reference Hysteresis	GEU (0.0 to 10.0%)	GEU	AEU (0.3%)	PID Zone 3
RDV	Reference Deviation	GEU (0.0 to 100.0%)	GEU	AEU (0.0%)	PID Zone 4

5.8 Auto Tuning Group (G.AT)

	<p>Press SET/ENT key to select the auto-tuning group. (Refer to parameter map)</p> <p style="text-align: center;"> $\begin{matrix} \blacktriangledown \uparrow \blacktriangledown \uparrow \blacktriangledown \uparrow \blacktriangledown \uparrow \blacktriangledown \uparrow \blacktriangledown \uparrow \blacktriangledown \uparrow \\ \text{G.AT} \leftrightarrow \text{G.PID} \leftrightarrow \text{PWD} \leftrightarrow \text{G.CTL} \leftrightarrow \text{G.IS} \leftrightarrow \text{G.DO} \\ \uparrow \downarrow \\ \text{G.COM} \leftrightarrow \text{G.RET} \leftrightarrow \text{G.ALM} \leftrightarrow \text{G.OUT} \leftrightarrow \text{G.IN} \\ \blacktriangledown \uparrow \blacktriangledown \uparrow \blacktriangledown \uparrow \blacktriangledown \uparrow \blacktriangledown \uparrow \blacktriangledown \uparrow \blacktriangledown \uparrow \end{matrix}$ </p>
	<p>The parameter to activate the auto-tuning function. When AT is set to ON, auto-tuning will begin, indicated by the AT light blinking. This parameter cannot be used if the controller does not have an active set point, either from running a program, or being in HOLD mode.</p>

 **AUTO TUNING (AT)**

The auto-tuning feature is used to let the controller measure process characteristics and automatically set the most appropriate values for the PID parameters. During the default auto-tuning process, the control outputs will function in an On/Off mode, and the controller will use the responses to calculate the needed PID values. During this setup process, the AT LED on the controller will blink.

Start the auto-tuning process while the controller is maintaining a set point, either while running a program, or while in HOLD mode. Auto-tuning will set the PID parameters for the PID zone which the set point is in, based on the PID reference point (RP) entered.

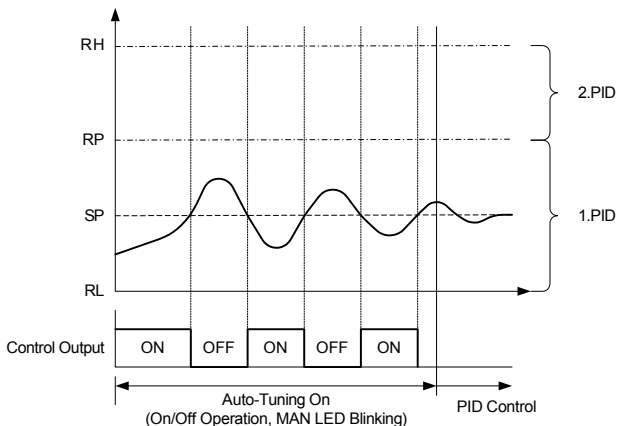

Fig 9: Auto-Tuning

Display During Auto-Tuning:

The AT LED on the front panel will blink at a 500 ms time interval.

Changing the Set Point During Auto-Tuning:

If the set point is changed during the auto-tuning process, the original set point will be maintained for the duration of the auto-tuning process. After auto-tuning is complete, the controller will change to the new set point.

Changing PID Parameters During Auto-Tuning:

The PID values can be changed during the auto-tuning process. After auto-tuning is complete, it will then use the auto-tune calculated PID values. Values changed after auto-tuning will remain set until auto-tuning is run again.

Auto-Tuning Interruptions or Errors:

The auto-tuning process will end without effect for any of the following reasons:

- Auto-tuning forced to end (Example: Controller power down or stop condition)
- Open sensor (S.OPN) input error detected during the auto-tuning process
- Auto-tuning cycle exceeds 24 hours.
- Control changed to manual (MAN) operation during auto-tuning.

PV **AT-G**

This parameter effects the proportional value derived by auto-tuning. Reduce the AT-G gain value and the cycle becomes more rapid, but more unstable. Increasing gain slows system reaction time, but system stability increases.

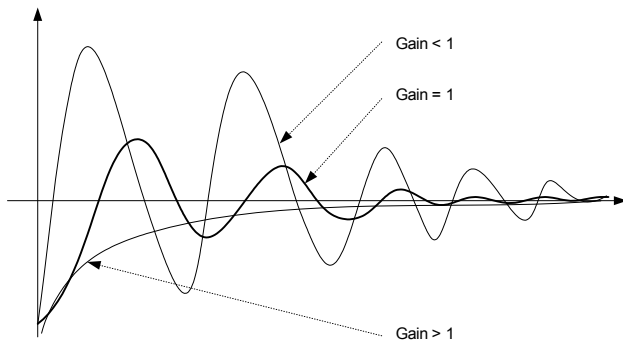

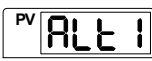
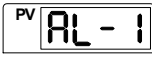





Fig 10: Auto-Tuning Gain

PID Group Parameter Summary

Display	Parameter	Setting Range	Unit	Default	Remark
AT	Auto Tuning	OFF, ON	ABS	OFF	Auto-Tune Activation
AT-G	AT Gain	0.1 to 10.0	ABS	1.0	Gain Value

5.9 Alarm Group (G.ALM)

	<p>Press SET/ENT key to select the alarm group. (Refer to parameter map in section 3.)</p> <p style="text-align: center;"> ▲▼ G.A.T ↔ G.PID ↔ PWD ↔ G.CTL ↔ G.IS ↔ G.DO ▲▼ ▲▼ G.COM ↔ G.RET ↔ <u>G.ALM</u> ↔ G.OUT ↔ G.IN ▲▼ </p>
	<p>The parameter to set the type of alarm to be set for alarm 1. The types of alarms selectable are shown in Table 3: Alarm Selection.</p>
	<p>The parameter to set the alarm trigger point for the alarm set in ALT1. This parameter displays if a high, low, or high and low limit alarm was selected for ALT1.</p>
	<p>This establishes the high deviation range to trigger the alarm of deviation. This parameter displays if a deviation alarm was selected in ALT1.</p>
	<p>This establishes the low deviation range to trigger the alarm of deviation. This parameter displays if a deviation alarm was selected in ALT1.</p>
	<p>The parameter to set the dead band (Hysteresis) of alarm 1.</p>
	<p>The parameter to set the delay time before of alarm 1 is triggered.</p>
<p style="text-align: center;">⋮</p>	<p>Note: The menus for alarm 2 and 3 are the same as alarm 1.</p>

NOTE Alarm Types and LED Display



- S indicates standby operation
- F for forward operation
- r for reverse (failsafe) operation
- Decimal point always displayed
- H indicates a high alarm
- L indicates a low alarm
- o for outside range of deviation band
- I for inside range of deviation band
- A indicates an absolute value alarm
- d indicates a deviation alarm

Alarm Output Settings:

- Forward: Relay energized in alarm condition
- Reverse: Failsafe operation. Relay energized during normal operating conditions

Standby Operation:

The alarm will not trigger if the alarm condition occurs during the following activities...

- during power-up
- the set point is changed
- the type of alarm is changed

Table 3: Alarm Selection

No.	Alarm Type	Operation		Standby		Display Data
		For	Rev	On	Off	
1	Absolute Value High Limit Alarm	✓		✓		AH.F
2	Absolute Value Low Limit Alarm	✓		✓		AL.F
3	High Limit Deviation Alarm	✓		✓		DH.F
4	Low Limit Deviation Alarm	✓		✓		DL.F
5	High Limit Deviation Alarm		✓	✓		DH.R
6	Low Limit Deviation Alarm		✓	✓		DL.R
7	High and Low Limit Deviation Alarm	✓		✓		DO.F
8	High and Low Limit Range Deviation Alarm	✓		✓		DI.F
9	Absolute Value High Limit Alarm		✓	✓		AH.R
10	Absolute Value Low Limit Alarm		✓	✓		AL.R
11	Absolute Value High Limit Alarm with Standby	✓			✓	AH.FS
12	Absolute Value Low Limit Alarm with Standby	✓			✓	AL.FS
13	High Limit Deviation Alarm with Standby	✓			✓	DH.FS
14	Low Limit Deviation Alarm with Standby	✓			✓	DL.FS
15	High Limit Deviation Alarm with Standby		✓		✓	DH.RS
16	Low Limit Deviation Alarm with Standby		✓		✓	DL.RS
17	High and Low Limit Deviation Alarm with Standby	✓			✓	DO.FS
18	High and Low Limit Range Deviation Alarm with Standby	✓			✓	DI.FS
19	Absolute Value High Limit Alarm with Standby		✓		✓	AH.RS
20	Absolute Value Low Limit Alarm with Standby		✓		✓	AL.RS

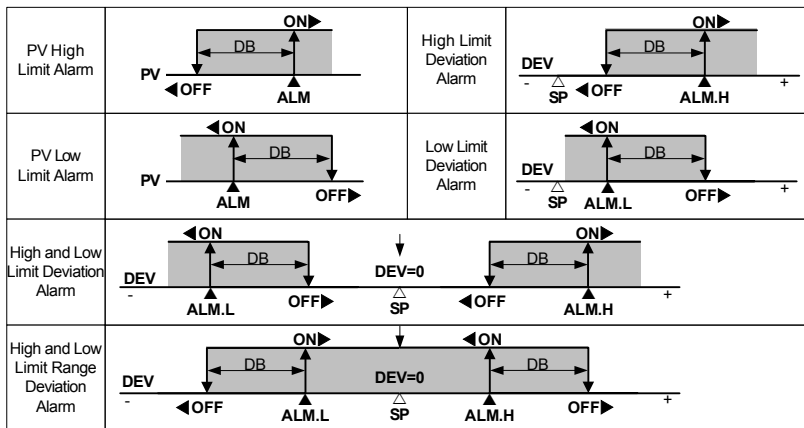

Fig 11: Alarm Operation

Alarm Group Parameter Summary

Display	Parameter	Setting Range	Unit	Default	Remark
ALT1	Alarm Type 1	Refer to Table 5: Alarm Selection	ABS	AH.F	
AL-1	Set value of ALT1	AEU (-100.0 to 100.0%)	AEU	AEU (100.0%)	Absolute Value Alarm
AL1.H	High Deviation Limit of Alarm 1	GEU (-100.0 to 100.0%)	GEU	GEU (0.0%)	Deviation Alarm
AL1.L	Low Deviation Limit of Alarm 1	GEU (-100.0 to 100.0%)	GEU	GEU (0.0%)	Deviation Alarm
A1DB	Alarm 1 DB	GEU (0.0 to 100.0%)	GEU	GEU (0.5%)	
A1DY	Delay Time of Alarm 1	0.00 to 99.59	MM.SS	0.00	
ALT2	Alarm Type 2	Refer to Table 5: Alarm Selection	ABS	AH.F	
AL-2	Set value of ALT2	AEU (-100.0 to 100.0%)	AEU	AEU (100.0%)	Absolute Value Alarm
AL2.H	High Deviation Limit of Alarm 2	GEU (-100.0 to 100.0%)	GEU	GEU (0.0%)	Deviation Alarm
AL2.L	Low Deviation Limit of Alarm 2	GEU (-100.0 to 100.0%)	GEU	GEU (0.0%)	Deviation Alarm
A2DB	Alarm 2 DB	GEU (0.0 to 100.0%)	GEU	GEU (0.5%)	
A2DY	Delay Time of Alarm 2	0.00 to 99.59	MM.SS	0.00	
ALT3	Alarm Type 3	Refer to (Table 5: Alarm Selection)	ABS	AH.F	
AL-3	Set value of ALT3	AEU (-100.0 to 100.0%)	AEU	AEU (100.0%)	Absolute Value Alarm
AL3.H	High Deviation Limit of Alarm 3	GEU (-100.0 to 100.0%)	GEU	GEU (0.0%)	Deviation Alarm
AL3.L	Low Deviation Limit of Alarm 3	GEU (-100.0 to 100.0%)	GEU	GEU (0.0%)	Deviation Alarm
A3DB	Alarm 3 DB	GEU (0.0 to 100.0%)	GEU	GEU (0.5%)	
A3DY	Delay Time of Alarm 3	0.00 to 99.59	MM.SS	0.00	

5.10 Retransmission Group (G.RET)

PV G.rEt

Press SET/ENT key to select the retransmission group. (Refer to parameter map)

G.AT ↔ G.PID ↔ PWD ↔ G.CTL ↔ G.IS ↔ G.DO
 ↑
 G.COM ↔ **G.RET** ↔ G.ALM ↔ G.OUT ↔ G.IN
 ↓

PV rEt

This parameter sets the type of retransmission scale to use. The three options are PV, SP, or MV. See notes below for an explanation of the retransmission types. Its default setting is PV.

PV rEtH

 PV rEtL

These parameters are used to scale the retransmitting output. They set the high and low limits for the retransmission output scale, as shown below. The retransmitting outputs will transmit 4 mA at the low limit (RETL) and 20 mA at the high limit (RETH) values. These limits are used when the retransmission type is set to PV or SP.

**PV and SP Type Retransmission Scale**

PV type retransmits based on the input value, SP retransmits based on the set point value.

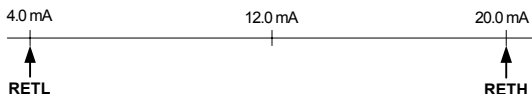



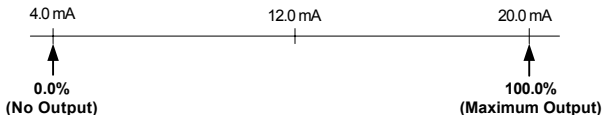

**MV Type Retransmission Scale**

MV type retransmits based on the full scale output and what is currently being transmitted by the control outputs

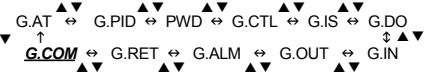
**Retransmission Group Parameter Summary**

Display	Parameter	Setting Range	Unit	Default	Remark
RET	Select Ret Type	PV, SP, MV	ABS	PV	
RETH	Ret Scale High Limit	T/C, RTD: INRH to INRL mV, V: INSH to INSL	AEU	INRH	Only Valid when RET is Set to PV or SP
RETL	Ret Scale Low Limit	RETH > RETL	AEU	INRL	

5.11 Communication Group (G.COM)

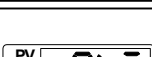
	<p>Press SET/ENT key to select the communication group. (Refer to parameter map)</p> <div style="text-align: center;">  </div>
	<p>The parameter to select the type of communication protocol to be used.</p>
	<p>The parameter to set the communication speed (baud rate). The baud rate can be set at 600 to 19200 bps (bytes per second). The default setting is for 9600 bps.</p>
	<p>The parameter to set communication parity. This can be set to NONE, EVEN, or ODD. The default setting is NONE.</p>
	<p>The parameter to set the communication stop bit. This can be set as 1 or 2. It is initially set as 1.</p>
	<p>The parameter to set the communication data length. This can be set to 7 or 8. The default setting is 8. This parameter is not displayed when the communication protocol (COM.P) is set for MODBUS ASCII or RTU.</p>
	<p>The parameter to set the communication address for the controller. This can be set as 1 to 99 pcs address. Its default setting is 1.</p>
	<p>The parameter to set communication response time. The RP.TM is the delay to return data to the upper level device after processing commands received from the upper level device. The setting RP.TM is based on the number of 10 ms intervals to delay (example: a setting of 2 will result in a 20 ms delay). If RP.TM is set to 0 it will immediately return a response once the command processing is complete.</p>



Request or download copies of the Precision Digital Nova Communication Manual for additional details about serial data communications with Precision Digital Nova products.

Communication Group Parameter Summary

Display	Parameter	Setting Range	Unit	Default	Remark
COM.P	Communication Protocol	PCC0, PCC1, MODBUS ASCII, MODBUS RTU, SYNC-Master, SYNC-Slave	ABS	PCC0	Option
BAUD	Baud Rate	600, 1200, 2400, 4800, 9600, 19200	ABS	9600	Option
PRTY	Parity	None, Even, Odd	ABS	None	Option
SBIT	Stop Bit	1, 2	ABS	1	Option
DLEN	Data Length	7, 8 (not used when set for MODBUS)	ABS	8	Option
ADDR	Address	1 to 99 (maximum of 31 connected at once)	ABS	1	Option
RP.TM	Response Time	0 to 10 (number of 10 ms intervals)	ABS	0	Option

6. Error Display and Correction

Error Message	Error Incident	Action Needed
E.SYS	EEPROM, DATA Loss	Needs Repair
E.RJC	RJC SENSOR Failure	Needs Repair
SP Decimal Flashing	Communication Failure	Check Comm Cable
S.OPN	Open Sensor Detected	Check Sensor
E.AT	Auto-Tune Timed Out (Over 24 Hours)	Check Process

7. Installation

7.1 Dimensions and Panel Cutouts

PD558

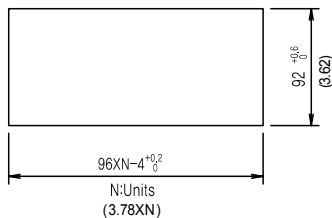
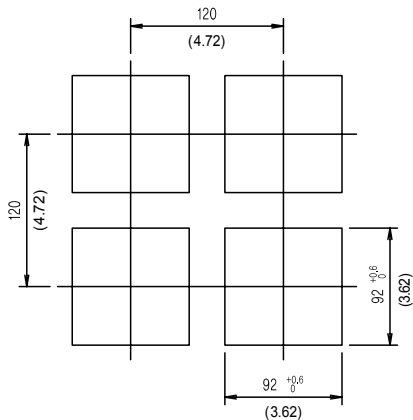
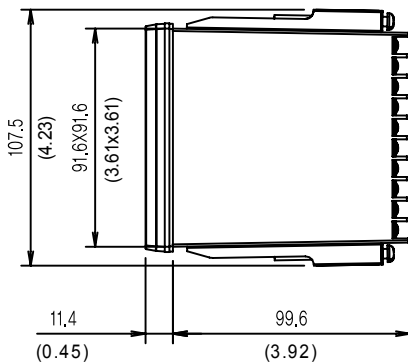
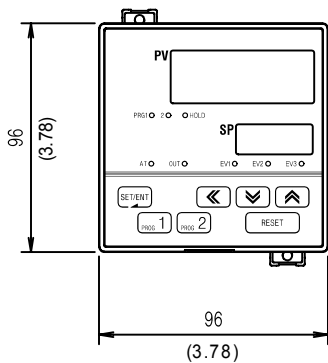

Units: mm
(inch) - for reference only

PD556

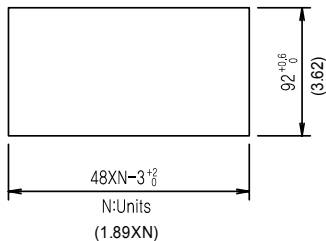
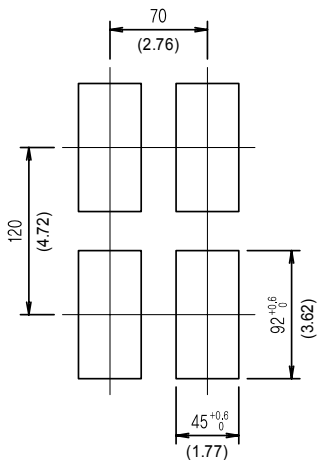
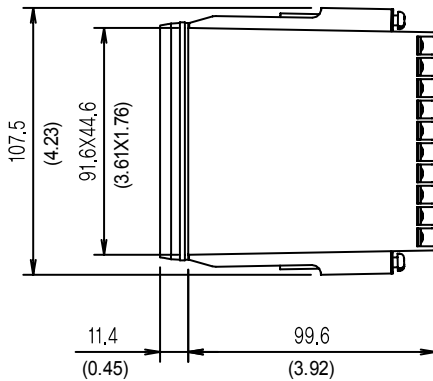
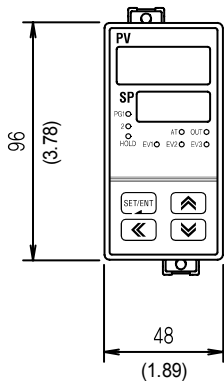

Units: mm
(inch) - for reference only

PD554

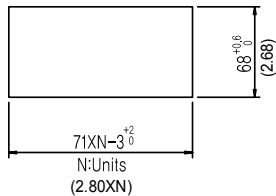
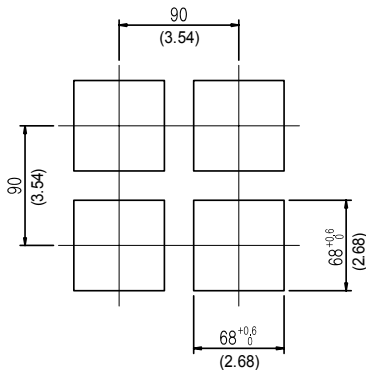
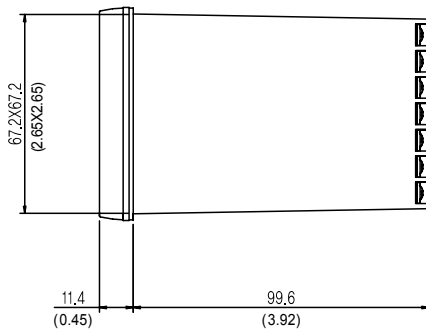
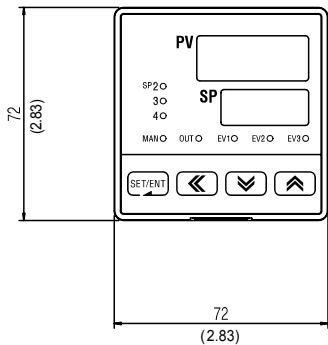

Units: mm
(inch) - for reference only

PD550

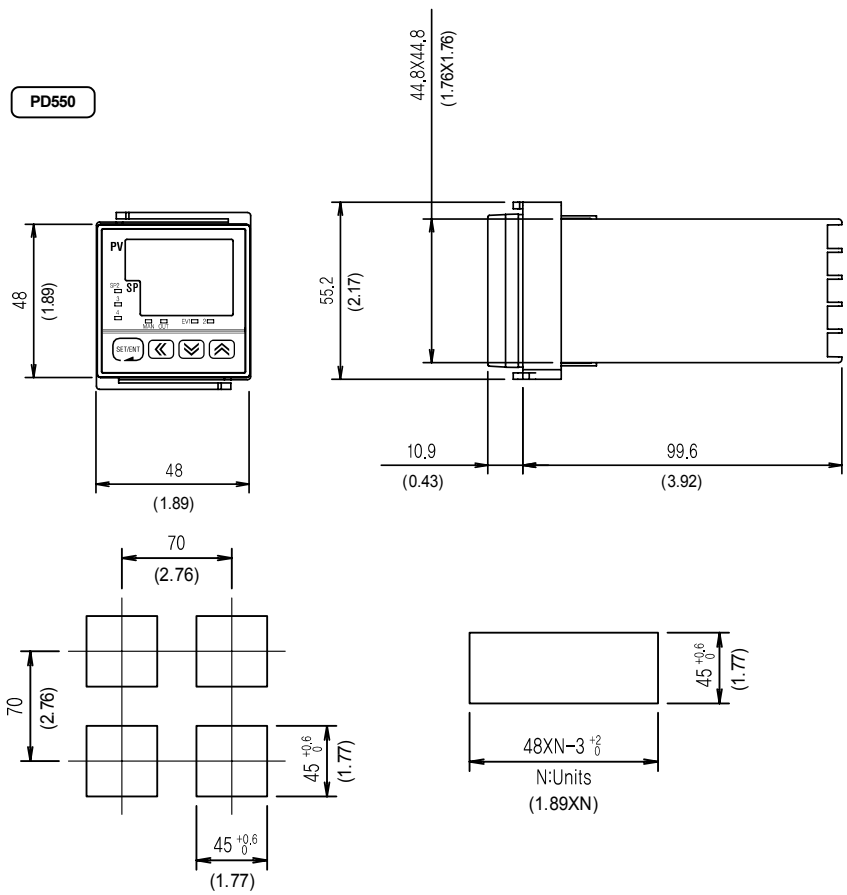

Units: mm
(inch) - for reference only

7.2 Panel Mounting

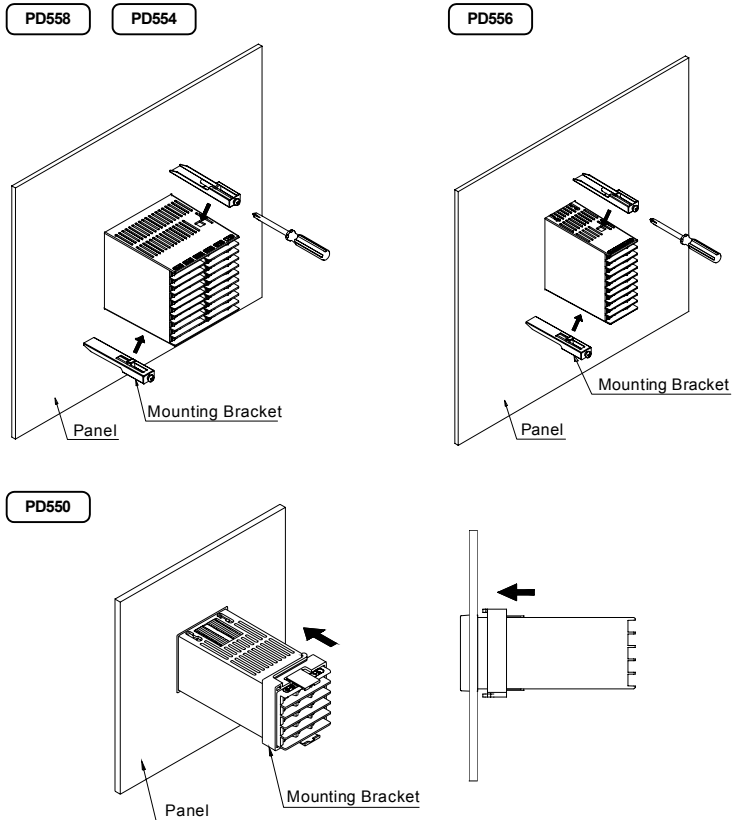
**Installation Steps**

1. Cut the mounting panel. (Refer to 7.1 Dimensions and Panel Cutouts)
2. Insert the controller through the front of the panel rear terminals first.
3. On applicable models, attach the right and left mounting bracket and secure it to the panel.
4. On 1/16 DIN controller models, slide the mounting bracket onto the back of the controller as shown, and slide it forward on the controller until the bracket locks in place, and the controller is secure.



Do not excessively tighten the mounting bracket screws. Excessive tightening may lead to controller or panel damage.

7.3 Power Cable Specification

Make power connections using 0.9 to 2.0 mm² or 16 AWG vinyl insulated wire. (Voltage rating of 300 VAC)

7.4 Terminal Specification

Use M3.5 screw-compatible crimp on terminals with insulating sleeve as shown below.

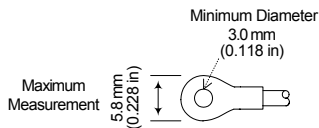

Note: Inches for reference only.

Use copper conductors only if the terminal is for connection to copper wire only.



Always turn off the source circuit breaker and check to ensure the power is off to the controller through the use of a tester prior to working on the wiring terminals.

- Never touch the terminals in the rear panel when power is supplied to the controller.
- Be sure to turn off the electric power before wiring any terminals.



Bind the wires connected to the controller terminals neatly together in order to prevent electromagnetic interference.

7.5 Terminal Assignment, Connections, and Ratings

PD558

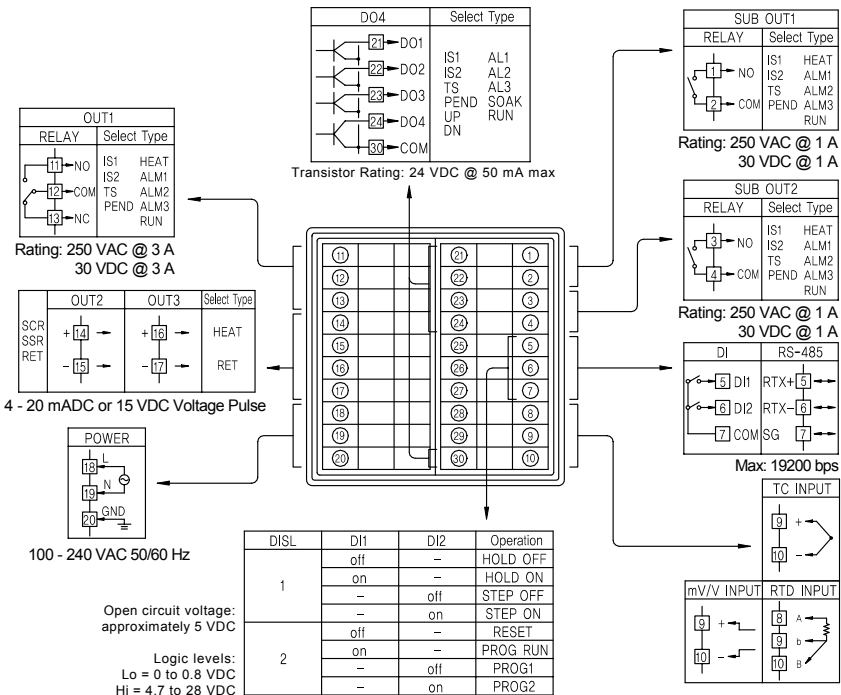

NO switches (external excitation not required) or open collector transistor

PD556

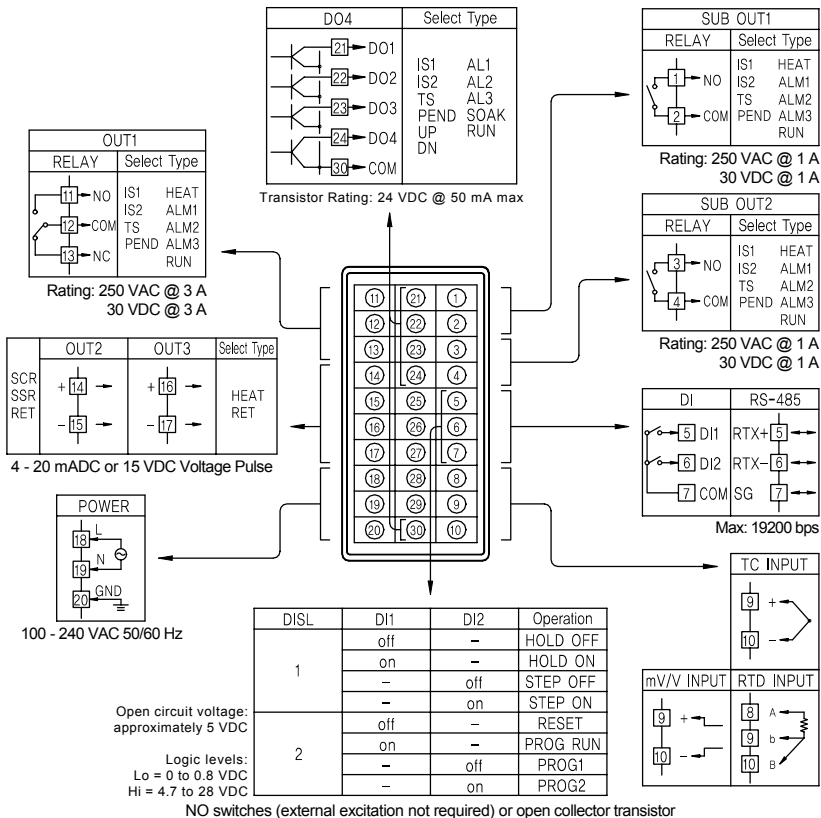

PD554

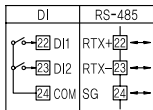

Open circuit voltage:
approximately 5 VDC

Logic levels:
Lo = 0 to 0.8 VDC
Hi = 4.7 to 28 VDC

DISL	DI1	DI2	Operation
1	off	—	HOLD OFF
	on	—	HOLD ON
	—	off	STEP OFF
2	—	on	STEP ON
	off	off	RESET
	on	—	PROG RUN
	—	off	PROG1
	—	on	PROG2

Max: 19200 bps

NO switches (external excitation not required)
or open collector transistor

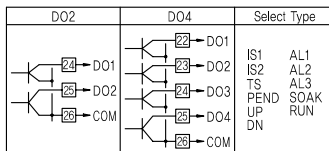

Transistor Rating: 24 VDC @ 50 mA max

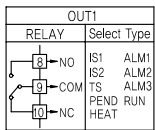

Rating: 250 VAC @ 3 A
30 VDC @ 3 A

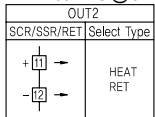

4 - 20 mADC or 15 VDC Voltage Pulse



100 - 240 VAC 50/60 Hz

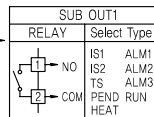
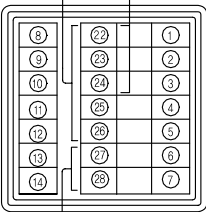

Rating: 250 VAC @ 1 A
30 VDC @ 1 A

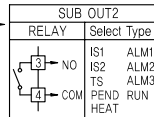

Rating: 250 VAC @ 1 A
30 VDC @ 1 A

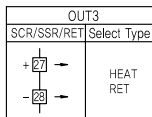

4 - 20 mADC or 15 VDC Voltage Pulse

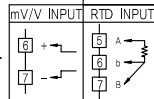

PD550

NO switches (external excitation not required) or open collector transistor

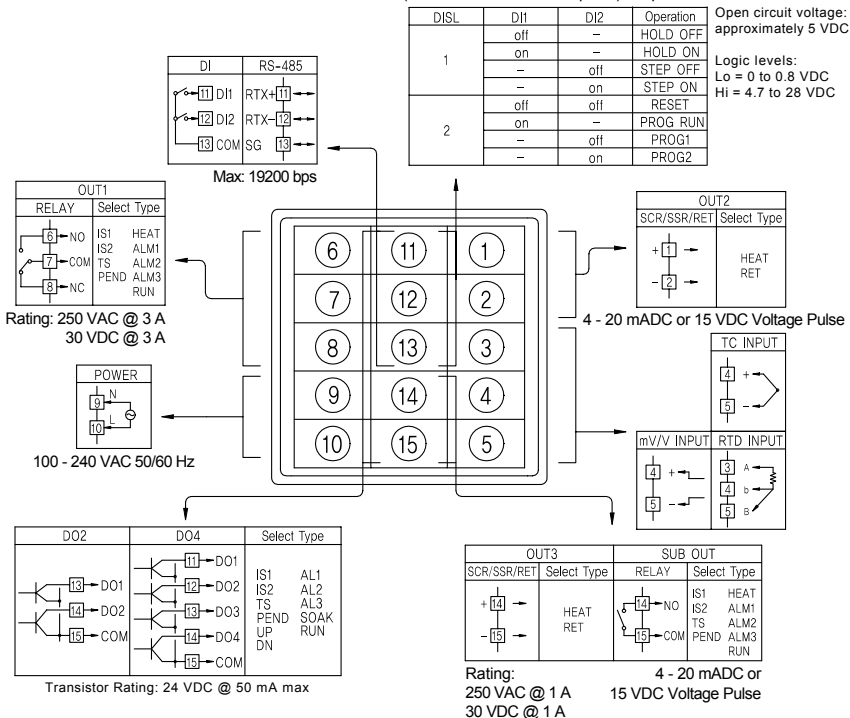

7.6 Grounding and Power Cable Connection

- Use a thick grounding cable of at least 2 mm² or 14 AWG and shorter than 20 m (approximately 22 ft) for class-3 grounding or better with a grounding resistance of less than 100 Ω.
- Be sure to ground from the grounding terminal to an independent grounding point. (1 point grounding)
- Use 0.9 to 2.0 mm² or 16 AWG vinyl insulated wire (Voltage rating 300VAC) or thicker for power cable connection.

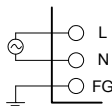

Be sure to connect L (Hot), N (neutral), and GND (ground) as indicated. Failure to wire the power and ground as indicated could result in damage to the controller.



To prevent electric shock, be sure to turn off power to the Nova Controller and the source circuit breaker before wiring.



- Be sure to connect to correct polarities. Connecting to a wrong polarity may cause damage or malfunction.
- Use shielded wires and ground the shielding to an independent grounding point.
- Keep the input signal and output wiring as far as possible away from the power and ground circuit.
- Use a wire with low conductive resistance and no three-wire resistance differential.

7.7 Signal Input Connection

(1) RTD Input

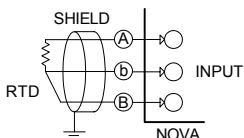

(2) DC Voltage Input

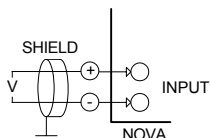

(3) DC Current Input

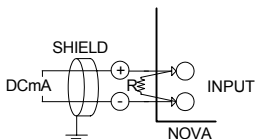

To accept a 4-20 mA signal, select 0.4 to 2.0 VDC input and connect a 100 Ω resistor across the input terminals as shown.

7.8 Analog Output Connection



To prevent electric shock, be sure to turn off power to the Nova Controller and the source circuit breaker before wiring.



- Be sure to connect to correct polarities. Connecting to a wrong polarity may cause a controller malfunction.
- Use shielded wires for the wiring and connect independently to ground (1 point grounding).

(1) Voltage Pulse Output (SSR) / Current Output (SCR)

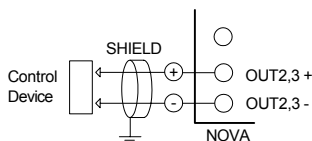

SCR : 4 to 20 mADC, 600 Ω maximum
SSR : 12 VDC min, 600 Ω minimum



To prevent electric shock, be sure to turn off power to the Nova Controller and the source circuit breaker before wiring.

(2) Retransmitting Output (RET)

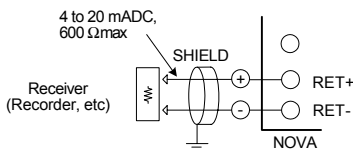

4 to 20 mADC,
600 Ω max



To prevent electric shock, be sure to turn off power to the Nova Controller and the source circuit breaker before wiring.

7.9 Relay Output Connection (RELAY)

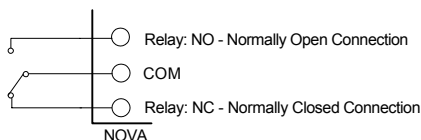

To prevent electric shock, be sure to turn off power to the Nova Controller and the source circuit breaker before wiring.

7.10 Digital Input Connection (DI)

- Use a no-voltage contact switch such as relay.
- The controller supplies the needed voltage (approx. 5 VDC) and current (approx. 1 mA) to trigger the input.
- When using an Open Collector (TR) as a trigger, use one with a 2V or lower voltage rating when "on" and 100 μ A or less leakage current when it is OFF.

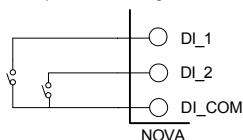

▲ Relay Contact Connection

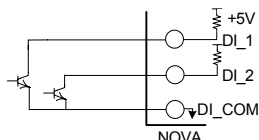

▲ Transistor Contact Connection



To prevent electric shock, be sure to turn off power to the Nova Controller and the source circuit breaker before wiring.

7.11 Use of an External Relay

Switching Inductive Loads

When using switching inductive loads, the use of RC networks (snubbers) for AC loads or diodes for DC loads is recommended to prevent disrupting the microprocessor's operation. The suppressors also prolong the life of the relay contacts. Suppression can be obtained with resistor-capacitor (RC) networks or diodes assembled by the user or purchased as complete assemblies.

For AC loads, choose R and C as follows:

R: 0.5 to 1 Ω for each volt across the contact

C: 0.5 to 1 μ F for each amp through closed contacts

Notes:

1. Use capacitors rated for 250 VAC.
2. RC networks may affect load release time of solenoid loads. Check to confirm proper operation.
3. RC networks are available from Precision Digital and should be applied to each relay contact switching an inductive load. Part number: PDX6901



If the load inductance is over the controller specifications, the output may need a RC filter (snubber) or diode to properly handle frequent relay switching operations.

(1) DC Auxiliary Relay

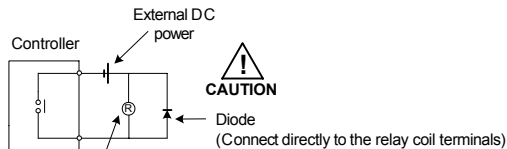

CAUTION Relay
(Verify relay coil ratings are less than the voltage and current ratings of the relay contacts of the controller)

(2) AC Auxiliary Relay

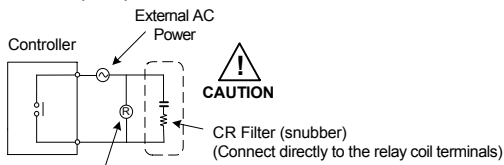

CAUTION Relay
(Verify relay coil ratings are less than the voltage and current ratings of the relay contacts of the controller)

7.12 Communication Wiring (RS-485)

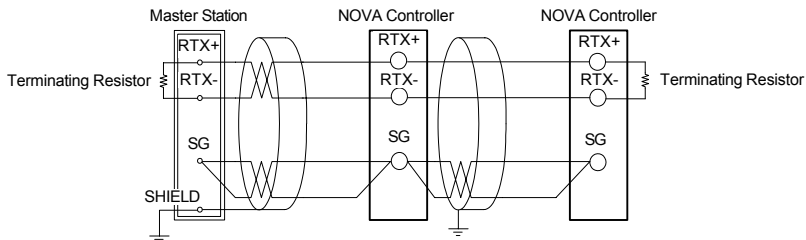

- Up to 31 slave controllers (Nova series controllers equipped with the RS-485 serial communication option) can be connected.
- Be sure to connect terminating resistors (220 Ω , 1/4 W) to slave and master controllers at communication channel ends as shown above.



To prevent electric shock, be sure to turn off power to the Nova Controller and the source circuit breaker before wiring.

Table of D-Registers

NO.	PROCESS	FUNCTION	SET POINT	SIGNAL	ALARM	PID	IN/OUT
0	0	100	200	300	400	500	600
1	NPV			1.IST	ALT1	ARW	IN-T
2	NSP			1.ISB	ALT2	FUZZY	INT-U
3	TSP			1.ISH	ALT3		IN.RH
4				1.ISL			IN.RL
5				1.ISD			IN.DP
6	MVOUT			2.IST	AL-1		IN.SH
7				2.ISB	AL-2		IN.SL
8				2.ISH	AL-3		IN.FL
9	PIDNO			2.ISL			BSL
10	NOWSTS			2.ISD			RSL
11		FKEY,RST/IF2		DO1	A1DB	1.P	BSP1
12		HOLD,OFF/ON		DO2	A2DB	1.I	BSP2
13		STEP,OFF/ON		DO3	A3DB	1.D	BSP3
14	ALSTS			DO4		1.MR	
15							BS0
16					A1DY		BS1
17	SIGNAL.STS				A2DY		BS2
18					A3DY		BS3
19	ERROR					RP1	BS4
20							
21		AT			AL1.H	2.P	OUT1
22		AT-G			AL2.H	2.I	OUT2
23					AL3.H	2.D	OUT3
24						2.MR	
25	PTNO						SUB1
26	SEG.NO				AL1.L		SUB2
27	END.SEG.NO				AL2.L		
28	RUN.TIME				AL3.L		
29	SET.TIME					RP2	
30							
31	LINK.CODE					3.P	HEAT2
32	RPT					3.I	
33	RST	PE-TM				3.D	HEAT3
34	REN					3.MR	
35		US1					
36	WAIT.TIME	US2					
37		LOCK					O.ACT
38		DI.SL					CT
39		DSP.H				RHY	
40		DSP.L					
41						4.P	OH
42						4.I	OL
43						4.D	

NO.	PROCESS	FUNCTION	SET POINT	SIGNAL	ALARM	PID	IN/OUT
44	0	100	200	300	400	500	600
45						4.MR	
46							PO
47							
48							
49						RDV	
50							
51							RET
52							RETH
53	U						RETL
54	s						
55	e						
56	r						
57							
58	A						
59	r						
60	e						
61	a						COMP
62							BAUD
63							PRTY
64							SBIT
65							DLEN
66							ADDR
67							RP.TM
68							
69							
70							
71							
72							
73							
74							
75							
76							
77							
78							
79							
80							
81							
82							
83							
84							
85							
86							
87							

NO.	PROCESS	FUNCTION	SET POINT	SIGNAL	ALARM	PID	IN/OUT
	0	100	200	300	400	500	600
88							
89							
90							
91							
92							
93							
94							
95							
96							
97							
98							
99							



NOTE



Read Only Location

NO.	RESERVED	RESERVED	RESERVED	PT INFO	PT1	PT2	RESERVED
	700	800	900	1000	1100	1200	1300
0							
1				TMU	1.LC	2.LC	
2				STC	1.SSP	2.SSP	
3				WZ			
4				WTM	1.SP1	2.SP1	
5					1.TM1	2.TM1	
6					1.TS1	2.TS1	
7					1.SP2	2.SP2	
8					1.TM2	2.TM2	
9					1.TS2	2.TS2	
10					1.SP3	2.SP3	
11					1.TM3	2.TM3	
12					1.TS3	2.TS3	
13					1.SP4	2.SP4	
14					1.TM4	2.TM4	
15					1.TS4	2.TS4	
16					1.SP5	2.SP5	
17					1.TM5	2.TM5	
18					1.TS5	2.TS5	
19					1.SP6	2.SP6	
20					1.TM6	2.TM6	
21					1.TS6	2.TS6	
22					1.SP7	2.SP7	
23					1.TM7	2.TM7	
24					1.TS7	2.TS7	
25					1.SP8	2.SP8	
26					1.TM8	2.TM8	
27					1.TS8	2.TS8	

NO.	RESERVED	RESERVED	RESERVED	PT INFO	PT1	PT2	RESERVED
	700	800	900	1000	1100	1200	1300
28					1.SP9	2.SP9	
29					1.TM9	2.TM9	
30					1.TS9	2.TS9	
31					1.SPA	2.SPA	
32					1.TMA	2.TMA	
33					1.TSA	2.TSA	
34					1.SPB	2.SPB	
35					1.TMB	2.TMB	
36					1.TSB	2.TSB	
37					1.SPC	2.SPC	
38					1.TMC	2.TMC	
39					1.TSC	2.TSC	
40					1.SPD	2.SPD	
41					1.TMD	2.TMD	
42					1.TSD	2.TSD	
43					1.SPE	2.SPE	
44					1.TME	2.TME	
45					1.TSE	2.TSE	
46					1.SPF	2.SPF	
47					1.TMF	2.TMF	
48					1.TSF	2.TSF	
49							
50							
51					1.RPT	2.RPT	
52					1.RST	2.RST	
53					1.REN	2.REN	
54							
55							
56							
57							
58							
59							
60							
61							
62							
63							
64							
65							
66							
67							
68							
69							
70							
71							

NO.	RESERVED	RESERVED	RESERVED	PT INFO	PT1	PT2	RESERVED
	700	800	900	1000	1100	1200	1300
72							
73							
74							
75							
76							
77							
78							
79							
80							
81							
82							
83							
84							
85							
86							
87							
88							
89							
90							
91							
92							
93							
94							
95							
96							
97							
98							
99							

Notes



Warranty and Return Information

Precision Digital warrants this product to be free from material defects and workmanship under normal use and service for three years.

Please contact Precision Digital Technical Support at (800) 610-5239 or e-mail at support@predig.com prior to any product return. When Technical Support determines a product should be returned, a Return Material Authorization (RMA) # which must be included on the return shipping label. Please also include the reason for return, date of purchase, contact name, and how to contact. Products returned for reasons other than repair may be subject to a restocking fee. Any returns under a warranty claim should be returned freight prepaid. Upon warranty confirmation Precision Digital will repair or replace and return the unit at no charge via UPS Ground. Other shipping is available upon request and at customer expense. All product returns should be shipped to:

Return Authorization # _____
Precision Digital, 19 Strathmore Road, Natick, MA 01760 USA
Attention: Technical Support

Precision Digital Technical Support is trained and eager to serve you. We have found most start-up problems to be the result of incorrect signal connections and/or programming. Most often Precision Digital Technical Support can quickly correct these issues over the telephone.

How to Contact Precision Digital

- For Technical Support
Call: (800) 610-5239 or (508) 655-7300
Fax: (508) 655-8990
Email: support@predig.com
- For Sales Support or to place an order please
Call: (800) 343-1001 or (508) 655-7300
Fax: (508) 655-8990
Email: sales@predig.com
- For the latest version of this manual, please visit
www.predig.com

