

DIGITAL CONTROLLER



NOVA PD540 Series

Instruction Manual

PD540 / 541 / 542 / 543 / 544 / 545 / 546 / 547 / 548 / 549

PRECISION DIGITAL CORPORATION

19 Strathmore Road • Natick MA 01760 USA

Tel (800) 343-1001 • Fax (508) 655-8990

**PRECISION
DIGITAL** 

Disclaimer

The information contained in this document is subject to change without notice. Precision Digital Corporation makes no representations or warranties with respect to the contents hereof, and specifically disclaims any implied warranties of merchantability or fitness for a particular purpose.

Registered Trademarks

MODBUS® is a registered trademark of Schneider Automation Inc. All other trademarks mentioned in this document are the property of their respective owners.

©2004 Precision Digital Corporation. All rights reserved.

Visit our Web Site
<http://www.predig.com>

Table of Contents

1. Safety Guide and Specifications	5
1.1 Specifications	7
2. Front Panel Buttons and LED Indicators	11
3. Parameter Map	12
4. Operation Flow Chart	14
5. Controller Parameter Setup	15
5.1 Input Group (G.IN)	15
5.2 Output Group (G.OUT)	19
5.3 Control Group (G.CTL)	22
5.4 SP Group (G.SP)	25
5.5 PID Group (G.PID)	27
5.6 Auto-Tuning Group (G.AT)	31
5.7 Alarm Group (G.ALM)	33
5.8 Retransmission Group (G.RET)	36
5.9 Communication Group (G.COM)	37
6. Error Display and Correction	39
7. Installation	40
7.1 Dimensions and Panel Cutouts	40
7.2 Panel Mounting	45
7.3 Power Cable Specifications	46
7.4 Terminal Specifications	46
7.5 Terminal Assignment, Connections, and Ratings	47

7.6 Grounding and Power Cable Connection	52
7.7 Signal Input Connection	52
7.8 Analog Output Connection	53
7.9 Relay Output Connection (RELAY)	54
7.10 Digital Input Connection (DI)	54
7.11 Use of an External Relay	54
7.12 Communication Wiring (RS-485)	55

Appendix

Table of D-Registers	56
----------------------------	----

Tables and Figures

Table 1: Universal Input Selection	15
Table 2: DI Operation	22
Table 3: Alarm Selection	34
Fig 1: Temperature Bias	17
Fig 2: Bias Formula Calculation	17
Fig 3: Time-Proportional PID Control Output	20
Fig 4: Output Delay and Timer Functions	22
Fig 5: Overshoot Suppression with Fuzzy Logic	27
Fig 6: Heating and Cooling Outputs Using PID Control	29
Fig 7: Heating On/Off and Cooling PID Outputs	29
Fig 8: Heating PID and Cooling On/Off Outputs	30
Fig 9: Auto-Tuning	31
Fig 10: Auto-Tuning Gain	32
Fig 11: Alarm Operation	34

1. Safety Guide and Specifications



The following safety symbols are used in this manual

- (1) This symbol notifies the user of specific information relating to the safe operation of the controller. Information noted with this symbol must be observed to protect the user from injury and to prevent damage to the product.
 - (A) For User: Be aware of this marking in the manual and refer to the explanation in the manual to prevent injury and damage.
 - (2) For Installer: Study the warnings marked to prevent injury and damage.



- (2) Functional earth terminal: This symbol indicates that the terminal must be connected to ground.



- (3) This symbol indicates additional information on the features of the product.



- (4) This symbol directs the reader to further information on the current topic.



Precautions Regarding This Instruction Manual

- (1) This manual must be kept in the possession of the end user and in a suitable place for the operator to study and to check the functions of the product.
- (2) The installer and operator should carefully study and understand how to operate this product before use.
- (3) This manual describes the functions of the product. Precision Digital Corporation does not guarantee that the functions will suit a particular purpose.
- (4) The contents of this manual have been reviewed for accuracy and correctness. However, should any errors or omissions come to the attention of the user, contact technical support as listed on the back of this manual.



Safety Procedures and Unauthorized Modification Warning

- (1) In order to protect this product and the system controlled by it against damage and ensure its safe use, make certain that all of the safety instructions and precautions in this manual are strictly adhered to.
- (2) Precision Digital Corporation does not guarantee safety if the products are not handled in accordance with this instruction manual.
 - ensure that such circuits are installed external to this product.
- (4) Do not make modifications or additions internally to the product. It may cause personal injury to the user or damage to the product.
- (5) Contact technical support as listed on the back of the manual for warranty and repair issues.
- (6) Exposure to excessive moisture, electrical overloads, or mechanical vibration may damage the product.



Limited Liability

Precision Digital Corporation assumes no liability to any party for any loss or damage, direct or indirect, caused by the use of or any unpredictable defect of the product.



Operational Environment Precautions

- (1) Only operate the controller when it is properly installed.
- (2) When installing the controller, select a location where:
 - Rear terminals are protected from accidental contact.
 - Mechanical vibrations are minimal.
 - No corrosive gas is present.
 - Temperature fluctuation is minimal.
 - Temperature can be maintained between 10 and 50 °C (50 and 110°F) with 20 to 90% RH.
 - No direct heat radiation is present.
 - High levels of electromagnetic interference are not present
 - The unit is not exposed to water.
 - No flammable materials are present.
 - Dust particles are not present in the air.
 - Exposure to ultraviolet rays is minimal.
 - Openings on the rear of the controller are not blocked.
- (3) This unit is suitable for installation in an environment classified as Pollution Degree 2.
- (4) This unit is designated as Installation Category II.
- (5) If the equipment is used in a manner not specified by the manufacturer, the protection provided by the equipment may be impaired.
- (6) A switch or circuit-breaker acting as the disconnect device shall be included in the application or the installation.



Controller Mounting Precautions

- Keep the input circuit wiring as far as possible away from power and ground circuits.
- Keep the units in 10 to 50°C (50 to 110°F) with 20% to 90% relative humidity (RH).
The controller may need a warm up period to return to operating temperature ranges when below 10°C.
- To prevent electric shock, be sure to turn off the power source and circuit breaker before wiring.
- The power requirements are 100 to 240 VAC, 50/60 Hz, 10 VA max. Do not switch power supplies without first disconnecting the power supply.
- Follow the operating procedures and precautions in the manual to avoid fire, shock, damage to the unit, or injury. Follow the operations and mounting directions indicated in this manual.
- Always create a ground connection where indicated, however do not ground to gas pipes, water pipes, lightning rods, or other potentially hazardous metal objects.
- Do not apply power to the unit until all connections have been made.
- Do not cover the venting holes in the rear of the unit.

1.1 SPECIFICATIONS

Except where noted all specifications apply to operation at 23°C.

General

DISPLAY	Two four digit red LED displays (-1999 to 9999) 1/16 DIN PV 11.3 mm (0.45 in), SP 9.5 mm (0.37 in) 3/16 DIN PV 14.0 mm (0.55 in), SP 12.0 mm (0.47 in) 1/8 (H) DIN PV 19.8 mm (0.78 in), SP 11.5 mm (0.45 in) 1/8 (V) DIN PV 13.6 mm (0.54 in), SP 10.5 mm (0.41 in) 1/4 DIN PV 20.5 mm (0.81 in), SP 11.0 mm (0.43 in)
SAMPLING TIME	250 ms
OVERRRANGE	Relays trip and PV display reads 9999
PROGRAMMING METHODS	Four front panel buttons, digital inputs, PC software
PID ZONES	3 programmable PID zone ranges, 1 PID PV deviation zone
NOISE FILTER	Programmable from 1 to 120.
RECALIBRATION	All ranges are calibrated at the factory. Recalibration is not required.
PASSWORD	Programmable password restricts modification of programmed settings.
POWER	100-240 VAC, 50/60 HZ, 10 Watts
FUSE	Required fuse: UL Recognized, 5 A max, slow blow Up to six units may share one 5 A fuse
ISOLATION	1.5 kV input/output-to-power line 500 V input-to-output
NUMBER OF SET POINTS	4 programmable set points
ENVIRONMENTAL	Operating temperature range: 10°C to 50°C (50°F to 110°F) Relative humidity: 20 to 90% non-condensing
MOUNTING	1/16, 3/16, 1/8, or 1/4 DIN size cutout required Two panel mounting bracket assemblies provided One one-piece bracket provided for the PD540
WARRANTY	Three years parts and labor
EXTENDED WARRANTY	Extended parts and labor warranties are available at time of ordering

Process and Temperature Inputs

TEMPERATURE DRIFT	Refer to accuracy specifications below
DECIMAL POINT	Up to three decimal places for process inputs: 9.999, 99.99, 999.9, or 9999
REAR JUNCTION COMPENSATION	Automatic or off settings for temperature inputs. No user calibration required.
OFFSET ADJUSTMENT	Four programmable input bias points, each with a programmable offset value.
SENSOR BREAK DETECTION	Open sensor indicated by PV display flashing S.OPN All PID control outputs transmit at the user programmed percent of full output scale set in parameters Po and Poc

UNIVERSAL INPUT TYPE AND ACCURACY

		Temp Range (°C)	Temp Range (°F)	Accuracy*	
Input Type	Thermocouple	K1	-200 to 1370	Temp Ranges > 0°C : ±0.1% ±1 digit Temp Ranges < 0°C : ±0.2% ±1 digit	
		K2	-199.9 to 999.9		
		J	-199.9 to 999.9		
		T	-199.9 to 400.0		
		B	0 to 1800	32 to 3300	Temp Ranges > 400°C : ±0.15% ±1 digit Temp Ranges < 400°C : ±5% ±1 digit
		R	0 to 1700	32 to 3100	All Temp Ranges ±0.15% ±1 digit
		S	0 to 1700	32 to 3100	
		E	-199.9 to 999.9	-300 to 1800	Temp Ranges > 0°C : ±0.1% ±1 digit Temp Ranges < 0°C : ±0.2% ±1 digit
		L	-199.9 to 900.0	-300 to 1600	Temp Ranges < 0°C : ±0.2% ±1 digit
		U	-199.9 to 400.0	-300 to 750	
N	-200 to 1300	-300 to 2400	Temp Ranges > 0°C : ±0.1% ±1 digit Temp Ranges < 0°C : ±0.25% ±1 digit		
W	0 to 2300	32 to 4200	All Temp Ranges ±0.2% ±1 digit		
Platinel II	0 to 1390	32 to 2500	All Temp Ranges ±0.1% ±1 digit		
RTD	PIA	-199.9 to 850.0	-300 to 1560	**All Temp Ranges ±0.1% ±1 digit	
	PIB	-199.9 to 500.0	-199.9 to 999.9		
	PIC	-19.99 to 99.99	-4.0 to 212.0	All Temp Ranges ±0.2% ±1 digit	
	JPIA	-199.9 to 500.0	-199.9 to 999.9	**All Temp Ranges ±0.1% ±1 digit	
JPIB	-150.0 to 150.0	-199.9 to 300.0			
DC Voltage	0.4 to 2.0 V	0.400 to 2.000	All Voltage Ranges ±0.1% ±1 digit Display range can be scaled between -1999 and 9999. To accept a 4-20 mA signal, select 0.4 to 2.0 VDC input and connect a 100 resistor across the input terminals.		
	1 to 5 V	1.000 to 5.000			
	0 to 10 V	0.00 to 10.00			
	-10 to 20 mV	-10.00 to 20.00			
	0 to 100 mV	0.0 to 100.0			

*Performance within recommended operating conditions (10 to 50°C, 20 to 90% RH)

**For a range scale of 0 to 100°C: +0.3°C +1 digit, and for a range scale of -100 to 100°C: +0.5°C +1 digit

Relay Outputs

RATINGS	Out1: 250 VAC @ 3 A or 30 VDC @ 3 A (resistive load) Sub1, Sub2: 250 VAC @ 1 A or 30 VDC @ 1 A (resistive load)
ELECTRICAL NOISE SUPPRESSION	A suppressor (snubber) should be connected to each relay contact switching inductive loads, to prevent disruption to the microprocessor's operation. Recommended suppressor value: 0.1 μ F/470 Ω , 250 VAC (PDX6901)
DEADBAND	For alarm operations, 0-100% of full scale, user selectable
HIGH OR LOW ALARM	User may program any relay for high or low trip point.
DEVIATION ALARM	User may program any relay for a high, low, or range set point deviation alarm.
RELAY OPERATION	Any relay may be set as a alarm relay or for time proportional PID control,
TIME DELAY	0 to 99 minutes 59 seconds alarm trip delay user selectable for each alarm. Time proportional PID control relay activation time delay of 0 to 99 minutes 59 seconds user selectable.
FAIL-SAFE OPERATION	Programmable, standby option independant for each alarm
AUTO INITIALIZATION	When power is applied to the controller, alarm relays will reflect the state of the input to the controller except standby alarms.

Analog Outputs

OUTPUT RANGE	Continuous PID or retransmitting: 4-20 mA (600 Ω maximum) Time Proportional PID: 15 VDC pulse (600 Ω minimum, current limited at 30 mA) high, less than 0.1 VDC low, cycle time 1 to 300 seconds, user selectable
SCALING RANGE	Retransmitting 4-20 mA outputs can be scaled for any display range low and high.
ACCURACY	$\pm 0.1\%$ of full scale

Serial Communications

PROTOCOLS	Modbus (ASCII, RTU), PC software, SYNC (master/slave SP control)
UNIT ADDRESS	1 to 99 (Max 31 units connected)
BAUD RATE	600, 1200, 2400, 4800, 9600, 19200 bps, user selectable
RESPONSE TIME	0 to 100 ms delay response time 10 ms increments user selectable
DATA	7 or 8 bit user selectable
PARITY	None, even, or odd

Approvals

UL RECOGNIZED	USA and Canada UL 3121-1, Process Control Equipment
UL FILE NUMBER	E244207
CE COMPLIANT	

2. Front Panel Buttons and LED Indicators

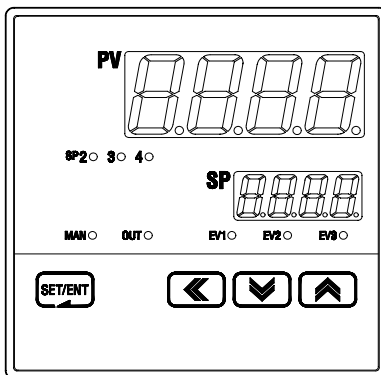

Control Keys

Key	Function
SET/ENT (ENTER)	Pressing SET/ENT key for at least 3 seconds switches between the operating display and the parameter setting display. This key is used to verify and bypass parameter settings when in the parameter group display.
▲ / ▼ (UP/DOWN)	Used to change the value of digits when setting parameters. Used to move between parameter groups.
◀ (SHIFT)	Used to move to the next digit when setting parameters.

LED Display

LED	Function
SP2, SP3, SP4 EV1, EV2, EV3 OUT MAN	LEDs activate when corresponding Set Point is selected for use. LEDs activate when corresponding relay events occur, such as alarm conditions. LED activated to display when control output is active. LED ON when manual output control mode is selected. LED blinks during auto-tuning setup process.

3. Parameter Map

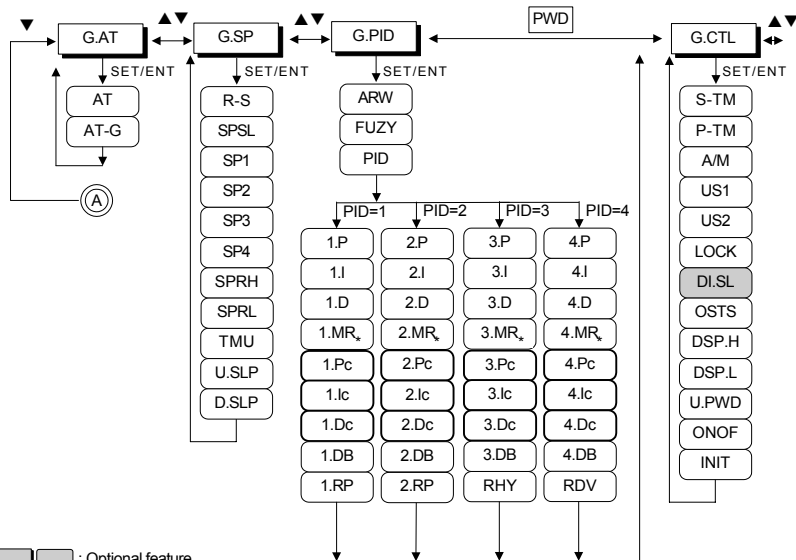

: Optional feature

: Selection in H/C model controllers only (H/C models and ON/OFF mode display HYS)

- * : This setting is active only when integral time is 0 and Heat or Cool is selected.
- ** : Menu only used if OUT2 or OUT3 selected for Heat or Cool control
- *** : OUT3 is an option for the PD540, PD541, PD544, and PD545, and standard on all other models
- **** : Option not available on the PD540 or PD541

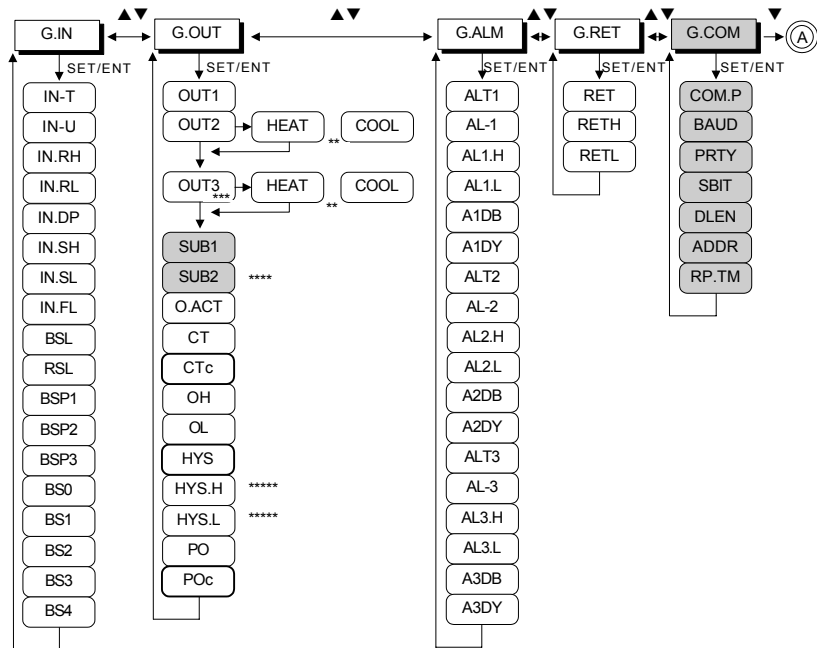

4. Operation Flow Chart

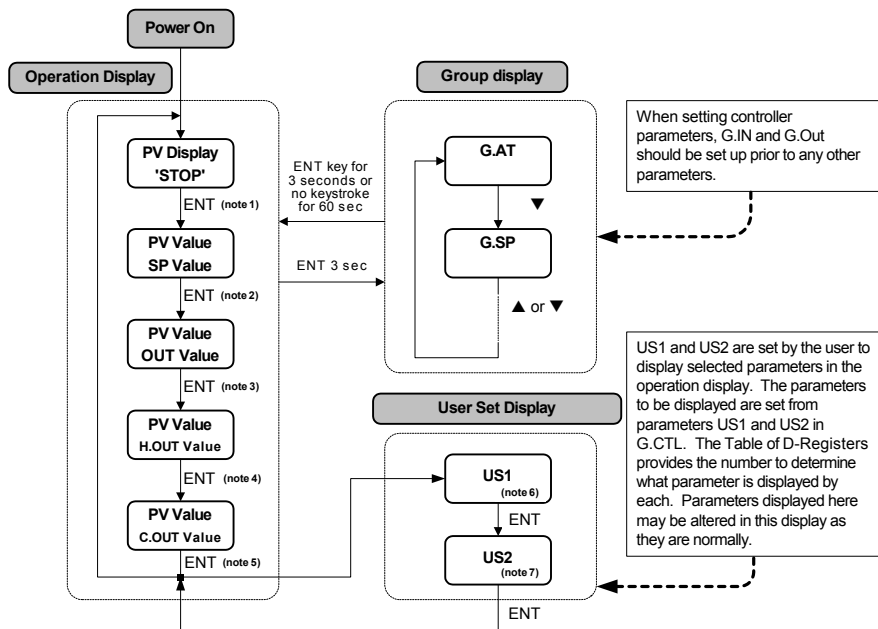

note 1: 'STOP' appears in the SP display when the controller has stopped output operation due to running time parameters. The Set Point may be changed while in 'Stop' mode.

note 2: Operation Display-1 : Initial display after power on. Active Set Point may be set through this menu.

note 3: Operation Display-2 : Output control display shows level of output as % of full output scale. May be set manually if output configured for manual operation.

note 4: Heating output display in Heating/Cooling models only.

note 5: Cooling output display in Heating/Cooling models only.

note 6: Only displayed when User Screen 1 is set in US1.

note 7: Only displayed when User Screen 2 is set in US2.

5. Controller Parameter Setup

5.1 Input Group (G.IN)

PV G.In

Press SET/ENT key to select input group. Press press ▲ or ▼ key to cycle through groups as shown below. (Refer to parameter map in section 3.)

G.AT ▲▼ ↔ G.SP ▲▼ ↔ G.PID ▲▼ ↔ PWD ▲▼ ↔ G.CTL ▲▼ ↔ **G.IN** ▲▼
 ▼ ↑
 G.COM ↔ G.RET ↔ G.ALM ↔ G.OUT
 ▲▼ ▲▼ ▲▼



Input group parameters should be established first, as changes to the input type may reset other parameter settings in other groups to their default value.

PV In-t

This parameter selects the type of input sensor used. Its default setting is type TC.K1. Refer to the following table showing the type of sensor inputs and select the desired input type.

Table 1: Universal Input Selection

display range : -5% to 105%

No.	TYPE	Temp.Range(°C)	Temp.Range(°F)	Group	DISP
1	K1	-200 to 1370	-300 to 2500	Thermocouple	TC.K1
2	K2	-199.9 to 999.9	0 to 2300		TC.K2
3	J	-199.9 to 999.9	-300 to 2300		TC.J
4	E	-199.9 to 999.9	-300 to 1800		TC.E
5	T	-199.9 to 400.0	-300 to 750		TC.T
6	R	0 to 1700	32 to 3100		TC.R
7	B	0 to 1800	32 to 3300		TC.B
8	S	0 to 1700	32 to 3100		TC.S
9	L	-199.9 to 900.0	-300 to 1600		TC.L
10	N	-200 to 1300	-300 to 2400		TC.N
11	U	-199.9 to 400.0	-300 to 750		TC.U
12	W	0 to 2300	32 to 4200		TC.W
13	Platinel II	0 to 1390	32 to 2500		TC.PL
14	PTA	-199.9 to 850.0	-300 to 1560	RTD (0.00385)	PTA
15	PTB	-199.9 to 500.0	-199.9 to 999.9		PTB
16	PTC	-19.99 to 99.99	-4.0 to 212.0		PTC
17	JPTA	-199.9 to 500.0	-199.9 to 999.9	RTD (0.00392)	JPTA
18	JPTB	-150.0 to 150.0	-199.9 to 300.0		JPTB
19	0.4 to 2.0V	0.400 to 2.000V		VDC	2V
20	1 to 5V	1.000 to 5.000V			5V
21	0 to 10V	0.00 to 10.00V			10V
22	-10 to 20mV	-10.00 to 20.00mV			20M
23	0 to 100mV	0.0 to 100.0mV		mVDC	100M

	<p>This parameter sets the display temperature unit for °C or °F. Its default selection is °C. Refer to Table 1 when changing the temperature unit for the temperature input range.</p>
	<p>This parameter sets the high limit of the temperature display range (maximum temperature displayed). For mV and V inputs, this sets the value of the high input of the input scale defined in In.SH.</p>
	<p>This parameter sets the low limit of the temperature display range (minimum temperature displayed). For mV and V inputs, this sets the low input of the input scale defined in In.SL.</p>
	<p>This parameter sets the position of the decimal point for mV or V inputs. The position of the decimal point can be set as 9999, 999.9, 99.99, or 9.999. Its default set value is 1.</p>
	<p>This parameter sets the high limit of the mV or V display scale. This value will be displayed when the input is set to the high input established in In.rH. Its default value is 100.0.</p>
	<p>This parameter sets the low limit of the mV or V display scale. This value will be displayed when the input is set to the low input established in In.rL. Its default value is 0.0.</p>
	<p>This parameter sets the PV filter for stabilization from electromagnetic noise and interference. This will effect the rate of change of the PV display value. Its default setting is OFF, and can be set from 1 to 120 seconds.</p>
	<p>This parameter to establishes PV behavior when an open input sensor is detected. When BSL is set to UP, the PV operates as if at the high input range. When BSL is set to DOWN, the PV operates as if at the low input range. Its default setting is UP. In the case of mV or V inputs, the default setting is OFF. An open sensor check is not performed in 10 V, 20 mV, or 100 mV input settings.</p>
	<p>This parameter determines if RJC for thermocouple inputs is used. RJC can be turned on or off. Its default setting is ON.</p>
<p style="text-align: center;">⋮</p>	<p>This parameter sets where the PV bias points occur. See Fig 1 and Fig 2 for further information about input bias operation.</p>
<p style="text-align: center;">⋮</p>	<p>This parameter sets the bias value at the corresponding bias point input values. These parameters establish the value of the offset at each of the defined BSP1 - BSP3 points. See Fig 1 and Fig 2 for further information about input bias operation.</p>

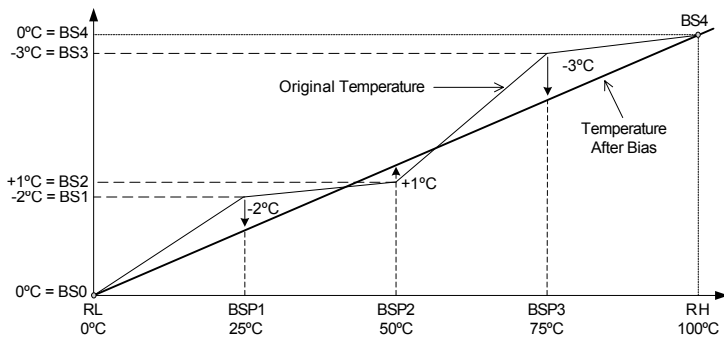

Fig 1: Temperature Bias

Example 1: The original temperature is shown within the range of 0°C (Range Low) and 100°C (Range High). Bias points have been used to adjust the displayed temperature as shown in the graph in Fig 1.

To establish this bias, the settings are shown below.

Temperature Settings to Establish Where the Bias Occurs				
RL	BSP1	BSP2	BSP3	RH
0°C	25°C	50°C	75°C	100°C
Bias Offset for Each Point				
BS0	BS1	BS2	BS3	BS4
0°C	-2°C	+1°C	-3°C	0°C

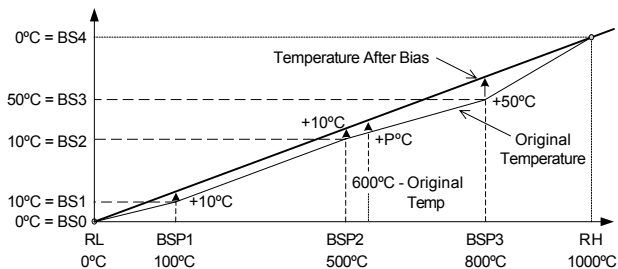

Fig 2: Bias Formula Calculation

Example 2: Temperature Bias Value (BS0 through BS4) = Temperature After Bias - Actual Temperature
 Display temperature after bias at 600°C actual temperature = P

$$P = 600 + (600 - BPS2) \times \frac{BS3 - BS2}{BSP3 - BSP2} + BS2$$

$$P = 600 + (600 - 500) \times \frac{50 - 10}{800 - 500} + 10 = 623^\circ\text{C Temperature After Bias}$$

Input Group Parameter Summary

Display	Parameter	Setting Range	Unit	Default	Remark
IN-T	Input Type	Refer to Table 1: Universal Input Selection	ABS	TC.K1	
IN-U	Display Unit	°C / °F	ABS	°C	T/C, RTD
IN.RH	Max PV Display Range	Within sensor input range Refer to Table 1 INRH > INRL	AEU	1370	
IN.RL	Min PV Display Range		AEU	-200	
IN.DP	Decimal Point Position	0, 1, 2, or 3	ABS	1	mV, V
IN.SH	Max Input Value Scale	-1999 to 9999 INSH > INSL Decimal position determined by IN.DP	ABS	100.0	mV, V
IN.SL	Min Input Value Scale			0.0	mV, V
IN.FL	PV Filter	OFF, 1 to 120	sec	OFF	
BSL	Open Sensor Behavior	OFF, UP, DOWN	ABS	UP	Not Used for VDC Input
RSL	RJC Operation	ON, OFF	ABS	ON	Only Used for TC Input
BSP1	Reference Bias Point 1	AEU (0.0 to 100.0%), RL≤BSP1≤BSP2≤BSP3≤RH	AEU	AEU (100.0%)	
BSP2	Reference Bias Point 2	AEU (0.0 to 100.0%), RL≤BSP1≤BSP2≤BSP3≤RH	AEU	AEU (100.0%)	
BSP3	Reference Bias Point 3	AEU (0.0 to 100.0%), RL≤BSP1≤BSP2≤BSP3≤RH	AEU	AEU (100.0%)	
BS0	Bias Value for RL Point	GEU (-100.0 to 100.0%)	GEU	0	
BS1	Bias Value at BSP1	GEU (-100.0 to 100.0%)	GEU	0	
BS2	Bias Value at BSP2	GEU (-100.0 to 100.0%)	GEU	0	
BS3	Bias Value at BSP3	GEU (-100.0 to 100.0%)	GEU	0	
BS4	Bias Value at RH	GEU (-100.0 to 100.0%)	GEU	0	





There are two types of engineering units values used in the setting of parameters, absolute engineering units (AEU) and general engineering units (GEU). An AEU parameter is set using an absolute value engineering unit that represents a specific point, such as a specific temperature or voltage level. An GEU parameter is set using engineering units, however it is a general value, and not tied to any input or output level.

For example: When establishing input bias, parameter BSP1 sets the specific PV value where bias point one will occur. This parameter has a unit designation of AEU. BS1, the amount of offset at BSP1 is set in engineering units, however this parameter occurs at whatever BSP1 is set to, and therefore does not have an absolute setting related to any input or output, it is just the amount of offset at where BSP1 occurs. While one is related to an absolute input value, and the other stand alone value, both are set as engineering units, such as BSP1 set as 100°C and BS1 set as 3°C.

5.2 Output Group (G.OUT)

	<p>Press SET/ENT key to select input group. (Refer to parameter map in section 3.)</p> <p style="text-align: center;"> ▲▼ G.AT ↔ G.SP ↔ G.PID ↔ PWD ↔ G.CTL ↔ G.IN ▼ ▲ G.COM ↔ G.RET ↔ G.ALM ↔ <u>G.OUT</u> </p>
---	---

	<p>This parameter sets the type of operation for output 1. (OUT1: relay output) The output can be set to HEAT, COOL, ALM1, ALM2, ALM3, or RUN. Its default setting is ALM1. (COOL is displayed on H/C models only. Skip when ON/OFF Mode selected.)</p>
---	---

	<p>This parameter establishes the type of operation for output 2. (OUT2: 4-20 mA or voltage pulse) Settings can be HEAT, COOL, or RET (retransmitting). Its default setting is HEAT. (COOL is displayed on H/C models only.)</p>
---	--

	<p>This parameter establishes the type of operation for output 3. (OUT3: 4-20 mA or voltage pulse) Settings can be HEAT, COOL, or RET (retransmitting). Its default setting is HEAT. (COOL is displayed on H/C models only.) Valid for models with OUT3 only.</p>
---	---

	<p>This parameter selects the type of output signal for each analog output (OUT2 and OUT3) when they are set to HEAT. The outputs can be set to SSR (pulse output) or SCR (4-20 mA). Its default setting is SSR.</p>
---	--

	<p>This parameter selects the type of output signal for each analog output (OUT2 and OUT3) when they are set to COOL. The outputs can be set to SSR (pulse output) or SCR (4-20mA). Its default setting is SSR.</p>
---	---

	<p>This parameter sets the type of operation for auxiliary output 1 (SUB1: relay output) Output can be set to HEAT, COOL, ALM1, ALM2, ALM3, or RUN. Its default setting is ALM2. (COOL is displayed on H/C models only. Menu appears only on models with the SUB1 output option.)</p>
---	---



	<p>This parameter sets the type of operation for auxiliary output 2 (SUB2: relay output) Output can be set to HEAT, COOL, ALM1, ALM2, ALM3, or RUN. Its default setting is ALM2. (COOL is displayed on H/C models only. Menu appears only on models with the SUB2 output option.)</p>
---	---

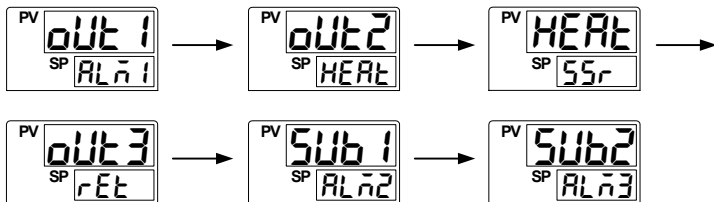

Output Group Menu Progression Example:

The following settings establish relay output 1 (OUT1) to trigger based on alarm 1, for analog output 2 (OUT2) to operate as a heating temperature controller outputting a voltage pulse, for analog output 3 (OUT 3) to output a retransmitting 4-20 mA signal, and for auxiliary relay outputs SUB1 and SUB2 to trigger with alarm 2 and alarm 3.

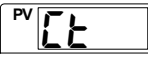

	<p>This parameter establishes reverse (REV) or forward (FWD) activation of the control outputs. In forward operation, the control outputs will be most active when the PV value is higher than the SP, as the controller acts to lower the PV. In reverse operation, the control outputs will be most active when the PV value is lower than the SP value, as the controller acts to increase the PV. The default setting is REV.</p>
	<p>This parameter establishes the cycle time for use with time-proportional PID relay or voltage pulse control when the outputs are set to HEAT or COOL. The cycle time can be set from 1 to 300 seconds. Its default setting is 2 seconds.</p>
	<p>This parameter establishes the cycle time for cooling outputs if cooling (COOL) control is set up with time-proportional PID control in a H/C model. (Example: OUT1 = Cool, OUT2 or OUT3 = Cool and set to SSR, SUB1 or SUB2 = Cool) The cycle time can be set from 1 to 300 seconds. Its default setting is 2 seconds.</p>

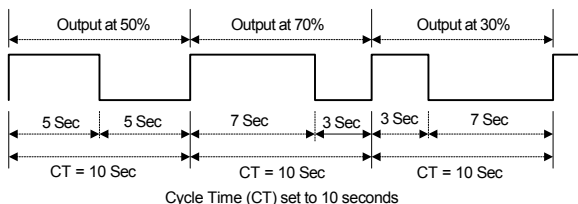
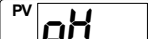
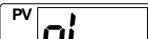
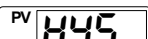

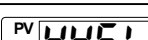

Fig 3: Time-Proportional PID Control Output

	<p>This parameter sets a high limit for the levels of the control output. This limits the output levels based on a percentage of their full scale. Its default setting is 100 (%).</p>
	<p>This parameter sets a low limit for the levels of the control output. This prevents the outputs from dropping below a certain level based on a percentage of their full scale. Its default setting is 0 (%). The outputs are limited by both the low and high limits.</p>
	<p>This parameter sets hysteresis in case of On/Off control output mode in a H/C model.</p>
	<p>This parameter sets the hysteresis high limit for on/off relay control mode in normal models (non-Heating/Cooling models).</p>
	<p>This parameter sets the hysteresis low limit for on/off relay control mode in normal models (non-Heating/Cooling models).</p>



This parameter establishes a specific output value for use in emergency conditions. This percentage level for the control outputs will be set after a PID algorithm error, A/D error, or open sensor error is detected.



This parameter is used to set a specific output value for the cooling control in a H/C model for use in error conditions. This percentage level for the control outputs will be set after a PID algorithm error, A/D error, or open sensor error is detected.

Output Group Parameter Summary

Display	Parameter	Setting Range	Unit	Default	Remark
OUT1	Select Output	HEAT, COOL, ALM1, ALM2, ALM3, RUN	ABS	ALM1	
OUT2	Select Output	HEAT, COOL, RET	ABS	HEAT	
OUT3	Select Output	HEAT, COOL, RET	ABS	RET	Models with OUT3 Only
HEAT	Select Output Type	SSR, SCR	ABS	SSR	When OUT 2, 3, Set for HEAT
COOL	Select Output Type	SSR, SCR	ABS	SSR	When OUT 2, 3, Set for HEAT
SUB1	Select Output	HEAT, COOL, ALM1, ALM2, ALM3, RUN	ABS	ALM2	Option
SUB2	Select Output	HEAT, COOL, ALM1, ALM2, ALM3, RUN	ABS	ALM3	Option
O.ACT	Reverse and Forward	REV, FWD	ABS	REV	
CT	Cycle Time 1	1 to 300 sec	sec	2 sec	
CTc	Cycle Time 2	1 to 300 sec	sec	2 sec	H/C Models Only
OH	High Limit value of Output	OL + 1 digit to 105.0% HC models: 0 to 105.0%, however OH>OL	%	100.0%	
OL	Low Limit value of Output	-5.0% to OH setting HC Type: 0 to 105.0%, However OH>OL	%	0% H/C: 100.0%	
HYS	Hysteresis	0.0 to 10.0%	%	0.5%	H/C Models Only, On/Off Mode
HYS.H	Hysteresis High	GEU (0.0 to 10.0% of sensor range)	GEU	GEU (0.5%)	Relay Cutoff, ON/OFF Mode
HYS.L	Hysteresis Low	GEU (0.0 to 10.0% of sensor range)	GEU	GU (0.5%)	Relay Activation, ON/OFF Mode
PO	Preset Output	-5.0 to 105.0% H/C Type : 0.0 to 105.0%	%	0.0%	
POc	Preset Output	0.0 to 105.0%	%	0.0%	H/C Models Only

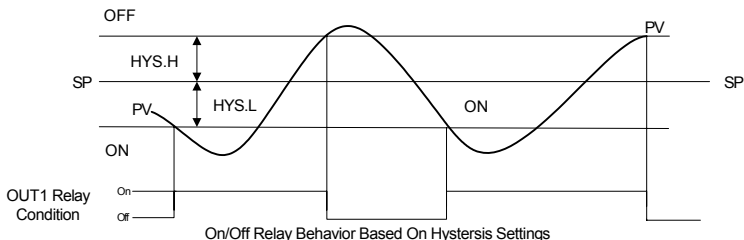

Note: In H/C models, HYS.H and HYS.L replaced by HYS, and range high and low is 1/2 HYS setting

5.3 Control Group (G.CTL)

PV **GCTL**

Press SET/ENT key to select control group. (Refer to parameter map in section 3.)

G.AT ↔ G.SP ↔ G.PID ↔ PWD ↔ **G.CTL** ↔ G.IN
 ↙ ↑ ↘ ↙ ↘ ↙ ↘ ↙ ↘ ↙ ↘
 G.COM ↔ G.RET ↔ G.ALM ↔ G.OUT

PV **S-TM**

This parameter establishes the delay time from power on to when the outputs are activated. This can be set from 0 to 99.95 (hours.minutes). Its default setting is OFF. See Fig. 4.

PV **P-TM**

This parameter establishes the running time for the controller outputs. P-TM can be set from 0 to 99.59 (hours.minutes). Its default setting is OFF. See Fig 4. Note that this time begins after the S-TM function.

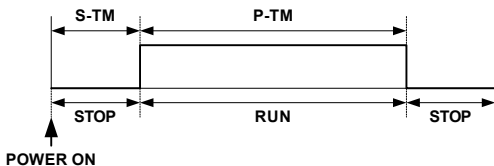

Fig 4: Output Delay and Timer Functions

PV **ARn**

This establishes the control mode as automatic (AUTO) or manual (MAN). When in manual mode, the output levels can be set by the user from the operation display, and the MAN LED will active on the front panel. The default setting is AUTO.

PV **US1**

PV **US2**

This parameter establishes the user screens for viewing, confirmation, and setup of commonly used parameters from the operation display. To add the parameter to the operation display, enter the corresponding number for the parameter from the Table of D-Registers as either US1 or US2. The default settings are OFF.





☞ See page 14 and the Operation Flow Chart for a map of the operation display.

PV **Lock**

Turning ON this parameter locks all settings from being changed. This applies to the operation display functions, such as changing the set point, as well as setting group parameters. If ON, only the LOCK parameter may be changed. The default setting is OFF.

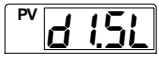
Table 2: DI Operation

DI.SL	DI1	DI2	Operation
OFF	-	-	DI Disabled
1	off	-	Stop
	on	-	Run
	-	off	SP1
	-	on	SP2
2	off	off	SP1
	on	off	SP2
	off	on	SP3
	on	on	SP4

	<p>This parameter establishes the operation of the digital input (DI) external contacts. The digital input operating configurations are shown in Table 2: DI Operation. This feature is only valid for models with digital inputs.</p>
	<p>When this parameter is on, the output settings will be displayed in the operation display. The settings of parameters OUT1, OUT2, OUT3, SUB1, and SUB2 will be shown. Only outputs built into the model being used will display. Its default setting is OFF.</p>
	<p>This parameter sets the high limit of the sensor input in the PV display. The PV value will not display higher than this limit, however the control functions will operate based on the actual input value.</p>
	<p>This parameter sets the low limit of the sensor input in the PV display. The PV value will not display lower than this limit, however the control functions will operate based on the actual input value.</p>
	<p>This parameter establishes the password for the controller. This password must be entered at the PWD screen before accessing the control group (G.CTL) or it will not access the setting groups after the PWD prompt. The default setting is "0". See the parameter map in section 3 for the location of the PWD prompt in the group menus.</p>

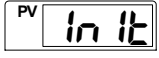

Be sure not to forget the password once it has been set. If the password is forgotten, contact technical support as listed on the back of this manual.

	<p>The parameter to set the relays for On/Off control mode. Control output is set to output 1 (Out1: Relay) when in On/Off mode. See hysteresis commands in the output group for operating the relay in On/Off mode.</p>
	<p>This parameter resets the parameters to their factory settings. To reset the controller, set this parameter to ON. After reset, it will return to the OFF setting.</p>











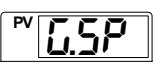
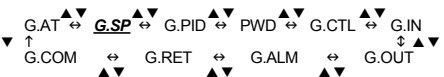
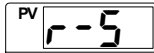



Most parameters will be reset to their default settings when the controller is initialized. Note the current settings before this is done so they can easily be restored after controller initialization.

Control Group Parameter Summary

Display	Parameter	Setting Range	Unit	Default	Remark
S-TM	Start Time Delay	Off (0.00) to 99.59 (hours.minutes)	Time	OFF	
P-TM	Process Run Time	Off (0.00) to 99.59 (hours.minutes)	Time	OFF	
A/M	Automatic/Manual	AUTO, MAN	ABS	AUTO	
US1	User Screen	OFF, D-Register Number 1 to 1299	ABS	OFF	
US2	User Screen	OFF, D-Register Number 1 to 1299	ABS	OFF	
LOCK	Parameter Lock	OFF, ON	ABS	OFF	
DI.SL	DI Selection	OFF, 1, 2	ABS	OFF	DI Option
OSTS	Output Status Display	OFF, ON	ABS	OFF	
DSP.H	Display High Limit	AEU (-5.0 to 105.0%), DSP.L<DSP.H	AEU	AEU (105.0%)	
DSP.L	Display Low Limit	AEU (-5.0 to 105.0%), DSP.L<DSP.H	AEU	AEU (-5.0%)	
U.PWD	User Password	0 to 9999	ABS	0	
ONOF	ON/OFF Mode	ON, OFF	ABS	OFF	Not in H/C Models
INIT	Factory Initialization	OFF, ON	ABS	OFF	

5.4 SP Group (G.SP)

	<p>Press SET/ENT key to select SP group. (Refer to parameter map in section 3.)</p> 
	<p>This parameter sets the running mode to RUN or STOP. In STOP mode, outputs are turned off, and no set point is maintained.</p>
	<p>This parameter selects which set point is active. There are four programmable set points, and one for use with SYNC-SLAVE communication. It can be set to RSP, SP1, SP2, SP3, or SP4. Its default setting is SP1.</p> <p> NOTE When using the communication option for SYNC-SLAVE control, the slave controllers must have SP5L set to RSP.</p>
  	<p>This parameter sets the value of each of the 4 programmable set points that can be selected to run. The parameter SP5L selects which set point to use.</p>
	<p>This parameter sets a high limit on what the set points can be programmed or changed to. This value may reset if the type of input is changed, or if parameter IN.RH or IN.RL (IN. SH or IN.SL if input type is mV or V) is changed.</p>
	<p>This parameter sets a low limit on what the set points can be programmed or changed to. This value may reset if the type of input is changed, or if parameter IN.RH or IN.RL (IN. SH or IN.SL if input type is mV or V) are changed.</p>
	<p>This parameter sets the time unit the controller uses for parameters with time components. This can be set to the format of HH.MM (hours.minutes) or MM.SS (minutes.seconds). Its default setting is HH.MM.</p> <p> NOTE Parameters S-TM and P-TM are not linked to TMU. The time unit setting of those parameters is always HH.MM (hours.minutes).</p>
 	<p>This parameter to sets the SP to ascend or descend gradually over time, dependant on the new SP selected. U.SLP (rate of ascension) and D.SLP (rate of descent) are the rate of change over time (time units set by parameter TMU) of the set point when the set point is changed. When U.SLP and D.SLP is set to OFF, the new SP is set instantly. The default setting of U.SLP and D.SLP is OFF.</p>

Set Point Group Parameter Summary

Display	Parameter	Setting Range	Unit	Default	Remark
R-S	Run/Stop	RUN, STOP	ABS	RUN	
SPSL	SP Select	RSP, SP1, SP2, SP3, SP4	ABS	SP1	
SP1	Set Point 1	AEU (0.0 - 100.0% of input range)	AEU	AEU (Input Range Low)	
SP2	Set Point 2	AEU (0.0 - 100.0% of input range)	AEU	AEU (Input Range Low)	
SP3	Set Point 3	AEU (0.0 - 100.0% of input range)	AEU	AEU (Input Range Low)	
SP4	Set Point 4	AEU (0.0 - 100.0% of input range)	AEU	AEU (Input Range Low)	
SPRH	Set Point Range High	AEU (0.0 - 100.0% of input range)	AEU	AEU (Input Range High)	
SPRL	Set Point Range Low	AEU (0.0 - 100.0% of input range)	AEU	AEU (Input Range Low)	
TMU	Time Unit	HH.MM (hours.minutes), MM.SS (minutes.seconds)	ABS	HH.MM	
U.SLP	Rate of Change for SP Increase	OFF (0), GEU (0.0%+1digit to 100.0%) per minute or second	GEU	OFF (0)	
D.SLP	Rate of Change for SP Decrease	OFF (0), GEU (0.0%+1digit to 100.0%) per minute or second	GEU	OFF (0)	

5.5 PID Group (G.PID)



The PID group selection does not appear when the controller is operating in On/Off mode

NOTE

PV 	Press SET/ENT key to select PID group. (Refer to parameter map in section 3.) <div style="text-align: center; margin-top: 10px;"> </div>
--------	--

PV 	The parameter sets the PV deviation width to prevent overshoot. When the control outputs reach this high limit value, they stop ordinary output action for integral control and use ARW (Anti-Reset Windup). When the setting is AUTO, this parameter is calculated automatically.
--------	--

PV 	This parameter activates the use of fuzzy logic. Fuzzy logic can be effective in suppressing overshoot and reducing PV variation that may occur once the PV has reached the SP. Refer to Fig 5: Overshoot Suppression with Fuzzy Logic.
--------	---

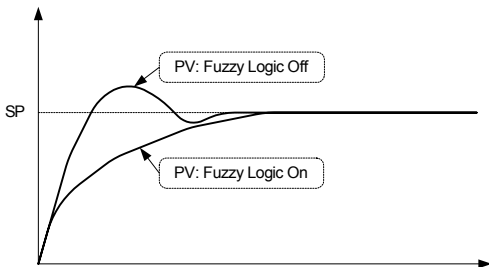
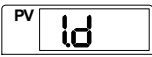

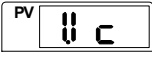

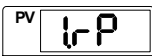
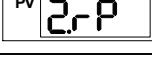



Fig 5: Overshoot Suppression with Fuzzy Logic

PV 	This parameter establishes the number of PID setting groups to be used in control output calculation. Up to 4 user defined groups of proportional, integral, and derivative value zones can be established. Use this setting to enter the setting menus for each PID group.
--------	---

PV 	This parameter sets the proportional operation for PID control. Setting range of 1.P is 0.1 (H/C model: 0.0) to 999.9%. Its default setting is 10.0%.
--------	---

PV 	This parameter sets the integration time for PID control. Setting ranges of I are OFF or 1 to 6000 seconds. Its default setting is 120 seconds
--------	--

	<p>The parameter to set derivation time for PID control. Setting ranges of 1.D are OFF or 1 to 6000 seconds. Its default setting is 30 seconds.</p>
	<p>The parameter to set the manual reset in the PID calculation. This setting only functions if the integral time setting is OFF. This setting always functions for H/C models.</p>
	<p>The parameter to set proportional operation for PID control for the cooling control in H/C models. Setting options are 0.0 (when using On/Off control) or 0.1 to 999.9%. Its default setting is 10.0%.</p>
	<p>The parameter to set integral time for PID control for the cooling control in H/C models. Setting options are OFF or 1 to 6000 seconds. Its default setting is 120 seconds.</p>
	<p>The parameter to set derivative time for PID control for the cooling control in H/C models. Setting options are OFF or 1 to 6000 seconds. Its default setting is 30 seconds.</p>
	<p>The parameter to set the dead band, in which there is no output from either the heating or cooling outputs. Refer to Fig 6, Fig 7, and Fig 8.</p>
<p style="text-align: center;">.</p>	<p>Note: The contents of PID Groups 2, 3, and 4 are the same as PID Group 1.</p>
	<p>This parameter establishes the PV range of each of the 3 main PID zones. The range of PID zone 1 is IN.RL (IN.SL if set for mV or V input) to 1.RP. The range of PID zone 2 is 1.RP to 2.RP. The range of PID zone 3 is 2.RP to IN.RH (IN.SH if set for mV or V input).</p>
	<p>This parameter establishes the range of each of the 3 main PID zones. The range of PID zone 1 is IN.RL (IN.SL if set for mV or V input) to 1.RP. The range of PID zone 2 is 1.RP to 2.RP. The range of PID zone 3 is 2.RP to IN.RH (IN.SH if set for mV or V input).</p>
	<p>This parameter establishes the hysteresis width of the PID zone.</p>
	<p>This parameter sets the range of deviation for PID zone 4. When the difference between the PV and SP is greater than this deviation range, the controller will utilize PID group 4 for PID settings. While the PV and SP are within this deviation difference, the controller will utilize whatever zone would normally be used based on the PV value.</p>

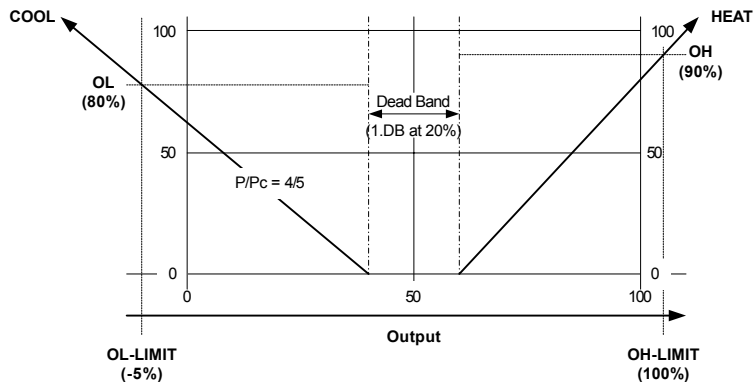

Fig 6: Heating and Cooling Outputs Using PID Control

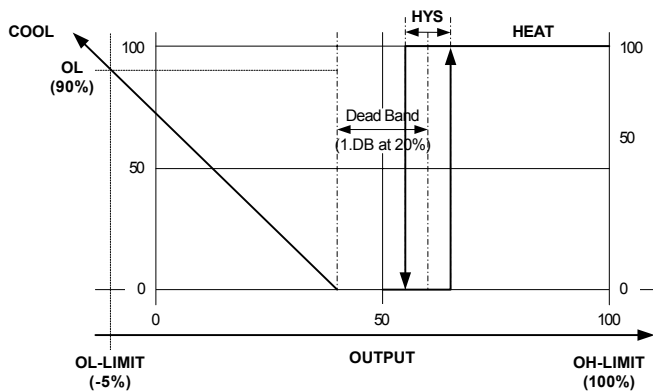

Fig 7: Heating On/OFF and Cooling PID Outputs

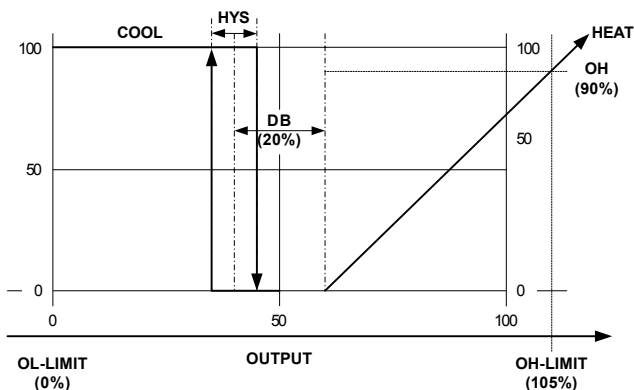

Fig 8: Heating PID and Cooling On/Off Outputs

PID Group Parameter Summary

Display	Parameter	Setting Range	Unit	Default	Remarks
ARW	Anti-Reset Wind-Up	Auto or 50.0 to 200.0%	%	Auto	
FUZY	Fuzzy	OFF, ON	ABS	OFF	
PID	PID Number	MENU (0), 1, 2, 3, or 4	ABS	MENU	
n.P	n.Proportional Band	0.1 (H/C Models:0.0) to 999.9%	%	10.0%	
n.I	n.Integral Time	OFF, 1 to 6000 seconds	sec	120 sec	
n.D	n.Derivative Time	OFF, 1 to 6000 seconds	sec	30 sec	
n.MR	n.Manual Reset	-5.0 to 105.0%	%	50.0%	
n.Pc	n.Proportional Band for Cooling Side	0.0 (ON/OFF Control) or 0.1 to 999.9%	%	10.0%	Used if I=0, or H/C Model
n.Ic	n.Integral Time for Cooling Side	OFF, 1 to 6000 sec	sec	120 sec	H/C Models Only
n.Dc	n.Derivative Time for Cooling Side	OFF, 1 to 6000 sec	sec	30 sec	H/C Models Only
n.DB	n.Deadband	-100.0 to 50.0%	%	3.0%	H/C Models Only
1.RP	Reference Point1	AEU (0.0%), $1.RP \leq 2.RP$	AEU	100.0%	PID Zone 1
2.RP	Reference Point2	$1.RP \leq 2.RP \leq AEU$ (100.0%)	AEU	100.0%	PID Zone 2
RHY	Reference Hysteresis	GEU (0.0 to 10.0%)	GEU	0.3%	PID Zone 3
RDV	Reference Deviation	GEU (0.0 to 100.0%)	GEU	0.0%	PID Zone 4

5.6 Auto-Tuning Group (G.AT)



AT group selection does not appear if operating in On/Off mode or when set for manual output control.

	<p>Press SET/ENT key to select AT group. (Refer to parameter map in section 3.)</p> <pre> ▲▼ ▲▼ ▲▼ ▲▼ ▲▼ ▲▼ G.AT ↔ G.SP ↔ G.PID ↔ PWD ↔ G.CTL ↔ G.IN ▲▼ ▲▼ ▲▼ ▲▼ ▲▼ ▲▼ ▲▼ ▲▼ ▲▼ ▲▼ ▲▼ ▲▼ ▲▼ ▲▼ ▲▼ ▲▼ ▲▼ ▲▼ ▲▼ ▲▼ ▲▼ ▲▼ G.COM ↔ G.RET ↔ G.ALM ↔ G.OUT ▲▼ ▲▼ ▲▼ ▲▼ </pre>
	<p>The parameter to activate the auto-tuning function. When AT is set to ON, auto-tuning will begin (indicated by the MAN light blinking). This parameter cannot be used if the controller is in STOP mode.</p>



Auto-Tuning (AT)

The auto-tuning feature is used to let the controller measure process characteristics and automatically set the most appropriate values for the PID parameters. During the initial auto-tuning process, the control outputs will function in an On/Off condition, and the controller will use the responses to calculate the needed PID values. During this setup process, the MAN LED on the controller will blink.

Start the auto-tuning process after setting a desired set point. Auto-tuning will set the PID parameters for the PID zone which the set point is in, based on the PID reference point (RP) entered.

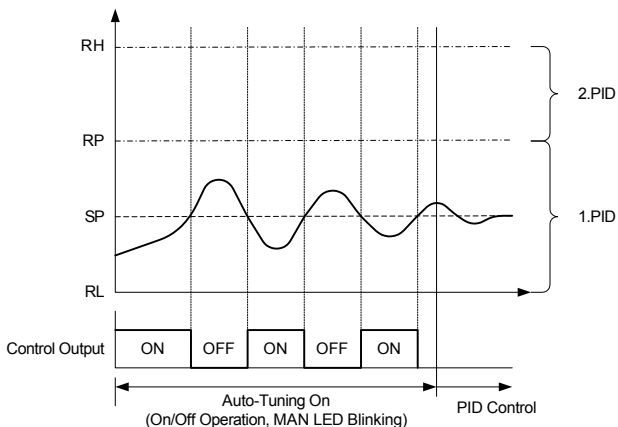

Fig 9: Auto-Tuning

Auto-Tuning the Heating/Cooling Outputs:

Auto-tuning of the heating/cooling outputs is the same process as the normal outputs. The PID heating/cooling parameters will be calculated. The parameters for the PID derivation time (1.D) will be the same for both the heating and cooling outputs.

Display During Auto-Tuning:

The MAN LED on the front panel will blink at a 500 ms time interval.

Changing the Set Point During Auto-Tuning:

If the set point is changed during the auto-tuning process, the original set point will be maintained for the duration of the auto-tuning process. After auto-tuning is complete, the controller will change to the new set point.

Changing PID Parameters During Auto-Tuning:

The PID values can be changed during the auto-tuning process. After auto-tuning is complete, it will then use the auto-tune calculated PID values. Values changed after auto-tuning will remain set until auto-tuning is run again.

Auto-Tuning Interruptions or Errors:

The auto-tuning process will end without effect for any of the following reasons:

- Auto-tuning forced to end (Example: Controller power down or stop condition)
- Open sensor (S.OPN) input error detected during the auto-tuning process
- Auto-tuning cycle exceeds 24 hours.
- Control changed to manual (MAN) operation during auto-tuning.

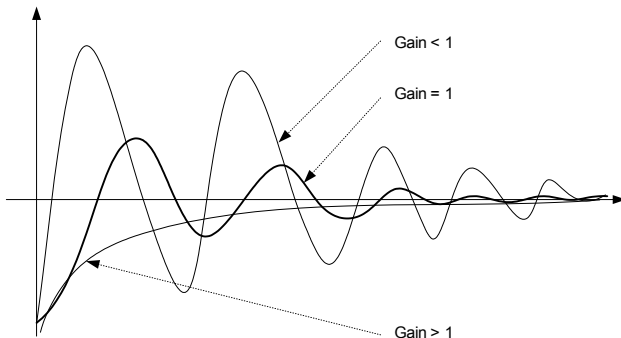
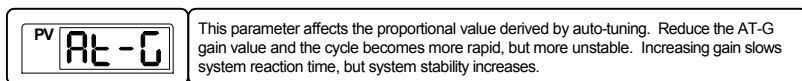

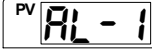



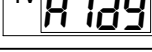

Fig 10: Auto-Tuning Gain

Auto-Tuning Group Parameter Summary

Display	Parameter	Setting Range	Unit	Default	Remark
AT	Auto-Tuning	OFF, ON	ABS	OFF	AT Activation
AT-G	AT Gain	0.1 to 10.0	ABS	1.0	Gain Value

5.7 Alarm Group (G.ALM)

	<p>Press SET/ENT key to select alarm group. (Refer to parameter map in section 3.)</p> <p style="text-align: center;"> ▲▼ G.AT ↔ G.SP ↔ G.PID ↔ PWD ↔ G.CTL ▲▼ G.IN ↑ G.COM ↔ G.RET ↔ <u>G.ALM</u> ↔ G.OUT ▲▼ ▲▼ ▲▼ </p>
	<p>This parameter sets the type of alarm to be set for alarm 1. The types of alarms selectable are shown in Table 3: Alarm Selection.</p>
	<p>This parameter sets the alarm trigger point for the alarm set in ALT1. This parameter displays if a high, low, or high and low limit alarm was selected for ALT1.</p>
	<p>This establishes the high deviation range to trigger the alarm of deviation. This parameter displays if a deviation alarm was selected in ALT1.</p>
	<p>This establishes the low deviation range to trigger the alarm of deviation. This parameter displays if a deviation alarm was selected in ALT1.</p>
	<p>This parameter sets the dead band (Hysteresis) of alarm 1.</p>
	<p>This parameter sets the delay time before of alarm 1 is triggered.</p>
<p style="text-align: center;">.</p>	<p>Note: The menus for alarm 2 and 3 are the same as alarm 1.</p>

NOTE Alarm Types and LED Display



- S indicates standby operation
- F for forward operation
- r for reverse (failsafe) operation
- Decimal point always displayed
- H indicates a high alarm
- L indicates a low alarm
- o for outside range of deviation band
- I for inside range of deviation band
- A indicates an absolute value alarm
- d indicates a deviation alarm

Alarm Output Settings:

- Forward: Relay energized in alarm condition
- Reverse: Failsafe operation. Relay energized during normal operating conditions

Standby Operation:

The alarm will not trigger if the alarm condition occurs during the following activities...

- during power-up
- the set point is changed
- the type of alarm is changed

Table 3: Alarm Selection

No.	Alarm Type	Operation		Standby		Display Data
		For	Rev	On	Off	
1	Absolute Value High Limit Alarm	✓		✓		AH.F
2	Absolute Value Low Limit Alarm	✓		✓		AL.F
3	High Limit Deviation Alarm	✓		✓		DH.F
4	Low Limit Deviation Alarm	✓		✓		DL.F
5	High Limit Deviation Alarm		✓	✓		DH.R
6	Low Limit Deviation Alarm		✓	✓		DL.R
7	High and Low Limit Deviation Alarm	✓		✓		DO.F
8	High and Low Limit Range Deviation Alarm	✓		✓		DI.F
9	Absolute Value High Limit Alarm		✓	✓		AH.R
10	Absolute Value Low Limit Alarm		✓	✓		AL.R
11	Absolute Value High Limit Alarm with Standby	✓			✓	AH.FS
12	Absolute Value Low Limit Alarm with Standby	✓			✓	AL.FS
13	High Limit Deviation Alarm with Standby	✓			✓	DH.FS
14	Low Limit Deviation Alarm with Standby	✓			✓	DL.FS
15	High Limit Deviation Alarm with Standby		✓		✓	DH.RS
16	Low Limit Deviation Alarm with Standby		✓		✓	DL.RS
17	High and Low Limit Deviation Alarm with Standby	✓			✓	DO.FS
18	High and Low Limit Range Deviation Alarm with Standby	✓			✓	DI.FS
19	Absolute Value High Limit Alarm with Standby		✓		✓	AH.RS
20	Absolute Value Low Limit Alarm with Standby		✓		✓	AL.RS

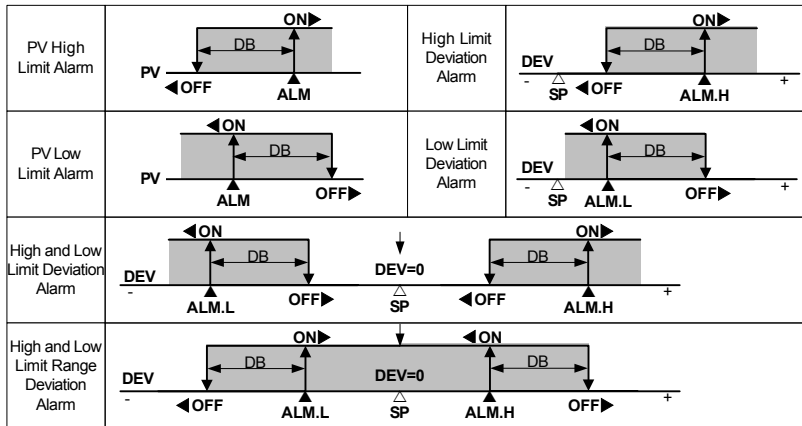

Fig 11: Alarm Operation

Alarm Group Parameter Summary

Display	Parameter	Setting Range	Unit	Default	Remark
ALT1	Alarm Type 1	Refer to Table 3: Alarm Selection	ABS	AH.F	
AL-1	Set Value of Alarm 1	AEU (-100.0 to 00.0%)	AEU	AEU (100.0%)	Absolute Value Alarm
AL1.H	High Deviation Limit of Alarm 1	GEU (-100.0 to 100.0%)	GEU	GEU (0.0%)	Deviation Alarm
AL1.L	Low Deviation Limit of Alarm 1	GEU (-100.0 to 100.0%)	GEU	GEU (0.0%)	Deviation Alarm
A1DB	Alarm 1 DB	GEU (0.0 to 100.0%)	GEU	GEU (0.5%)	
A1DY	Delay Time of Alarm 1	0.00 to 99.59	MM.SS	0.00	
ALT2	Alarm Type 2	Refer to Table 3: Alarm Selection	ABS	AH.F	
AL-2	Set Value of Alarm 2	AEU (-100.0 to 100.0%)	AEU	AEU (100.0%)	Absolute Value Alarm
AL2.H	High Deviation Limit of Alarm 2	GEU (-100.0 to 100.0%)	GEU	GEU (0.0%)	Deviation Alarm
AL2.L	Low Deviation Limit of Alarm 2	GEU (-100.0 to 100.0%)	GEU	GEU (0.0%)	Deviation Alarm
A2DB	Alarm 2 DB	GEU (0.0 to 100.0%)	GEU	GEU (0.5%)	
A2DY	Delay Time of Alarm 2	0.00 to 99.59	MM.SS	0.00	
ALT3	Alarm Type 3	Refer to Table 3: Alarm Selection	ABS	AH.F	
AL-3	Set Value of Alarm 3	AEU (-100.0 to 100.0%)	AEU	AEU (100.0%)	Absolute Value Alarm
AL3.H	High Deviation Limit of Alarm 3	GEU (-100.0 to 100.0%)	GEU	GEU (0.0%)	Deviation Alarm
AL3.L	Low Deviation Limit of Alarm 3	GEU (-100.0 to 100.0%)	GEU	GEU (0.0%)	Deviation Alarm
A3DB	Alarm 3 DB	GEU (0.0 to 100.0%)	GEU	GEU (0.5%)	
A3DY	Delay Time of Alarm 3	0.00 to 99.59	MM.SS	0.00	

5.8 Retransmission Group (G.RET)

PV G.RET

Press SET/ENT key to select retransmission group. (Refer to parameter map.)

PV rEt

This parameter sets the type of retransmission scale to use. The three options are PV, SP, or MV. See notes below for an explanation of the retransmission types. Its default setting is PV.

PV rETH

PV rETL

These parameters are used to scale the retransmitting output. They set the high and low limits for the retransmission output scale, as shown below. The retransmitting outputs will transmit 4 mA at the low limit (RETL) and 20 mA at the high limit (RETH) values. These limits are used when the retransmission type is set to PV or SP.

**PV and SP Type Retransmission Scale**

PV type retransmits based on the input value, SP retransmits based on the set point value.

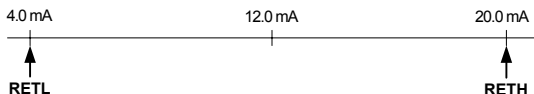
**MV Type Retransmission Scale**

MV type retransmits based on the full scale output and what is currently being transmitted by the control outputs

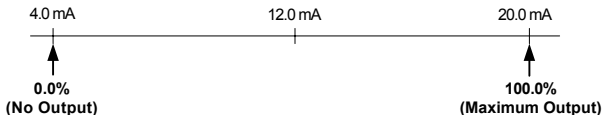
**Retransmission Group Parameter Summary**

Display	Parameter	Setting Range	Unit	Default	Remark
RET	Select Ret Type	PV, SP, MV	ABS	PV	
RETH	Ret Scale High Limit	T/C, RTD: INRH to INRL mV, V: INSH to INSL RETH > RETL	AEU	INRH	Only valid when RET is set to PV or SP
RETL	Ret Scale Low Limit		AEU	INRL	

Communication Group Parameter Summary

Display	Parameter	Setting Range	Unit	Default	Remark
COM.P	Communication Protocol	PCC0, PCC1, MODBUS ASCII, MODBUS RTU, SYNC-Master, SYNC-Slave	ABS	PCC0	Option
BAUD	Baud Rate	600, 1200, 2400, 4800, 9600, 19200	ABS	9600	Option
PRTY	Parity	None, Even, Odd	ABS	None	Option
SBIT	Stop Bit	1, 2	ABS	1	Option
DLEN	Data Length	7, 8 (not used when set for MODBUS)	ABS	8	Option
ADDR	Address	1 to 99 (maximum of 31 connected at once)	ABS	1	Option
RP.TM	Response Time	0 to 10 (number of 10ms intervals)	ABS	0	Option

6. Error Display and Correction

Error Message	Error Incident	Action Needed
E.SYS	EEPROM, Data Loss	Needs Repair
E.RJC	RJC Sensor Failure	Needs Repair
SP Decimal Flashing	Communication Failure	Check Comm Cable
S.OPN	Open Sensor Detected	Check Sensor
E.AT	Auto-Tune Timed Out (Over 24 Hours)	Check Process

7. Installation

7.1 Dimensions and Panel Cutouts

PD548-PD549

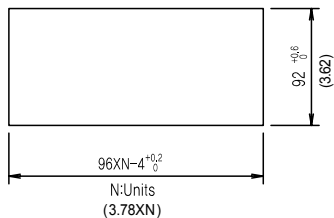
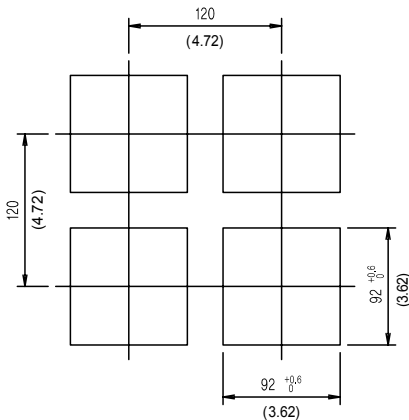
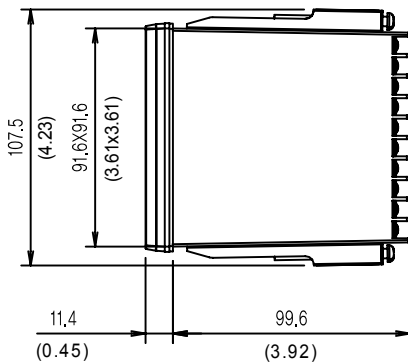
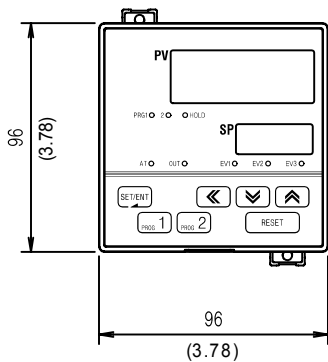

Units: mm
(inch) - for reference only

PD546-PD547

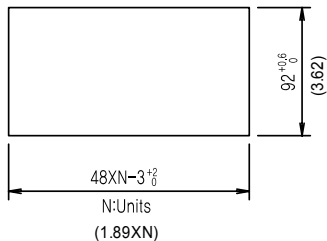
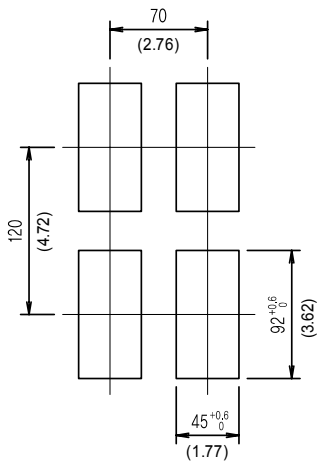
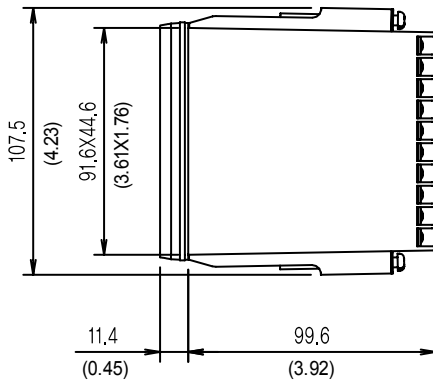
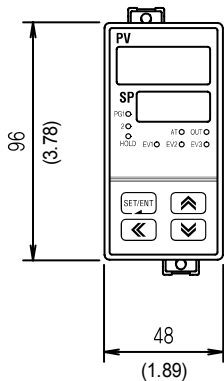

Units: mm
(inch) - for reference only

PD544-PD545

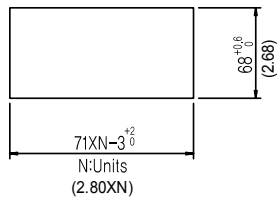
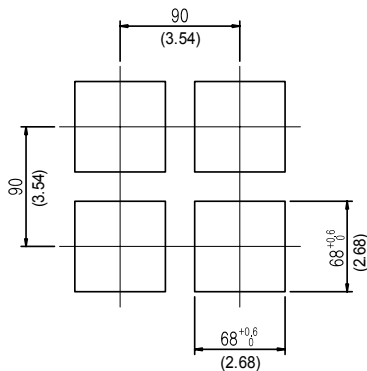
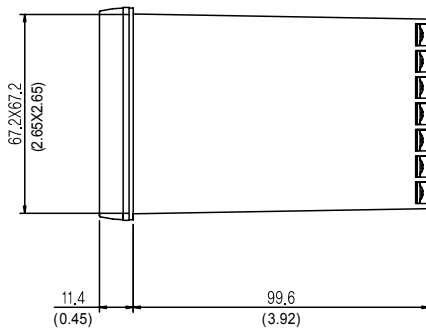
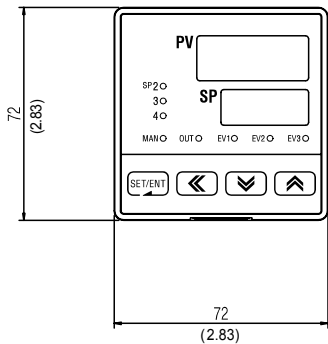

Units: mm
(inch) - for reference only

PD542-PD543

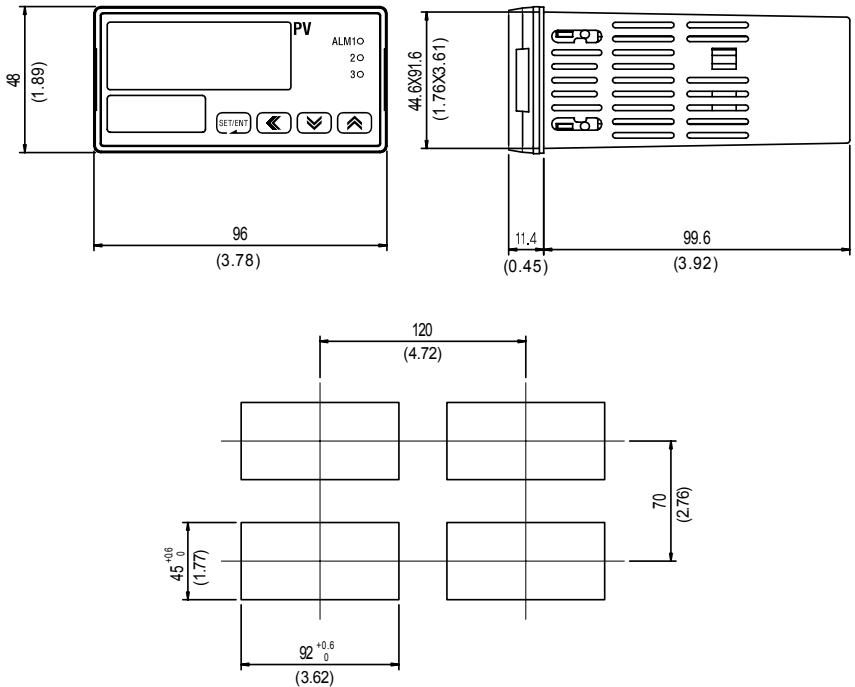

Units: mm
(inch) - for reference only

PD540-PD541

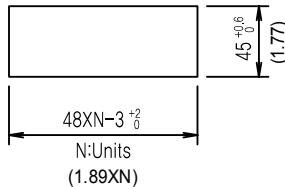
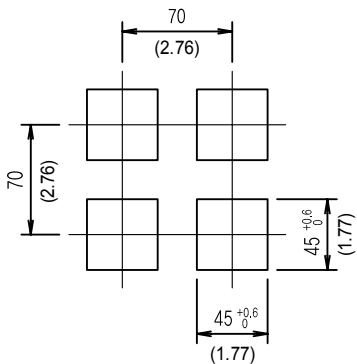
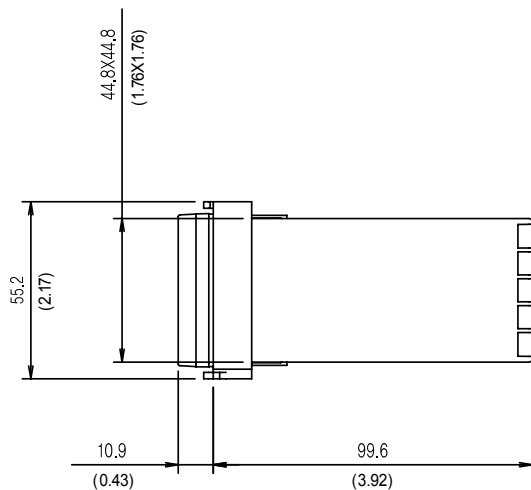
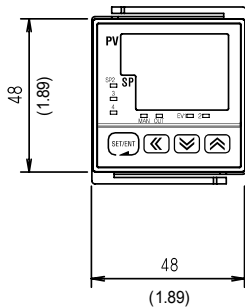

Units: mm
(inch) - for reference only

7.2 Panel Mounting

PD548-PD549

PD544-PD545

PD546-PD547

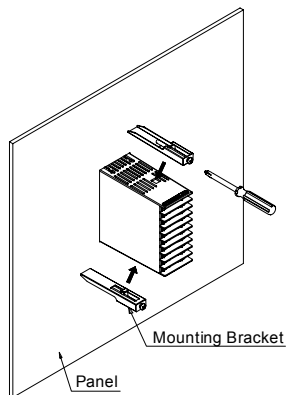
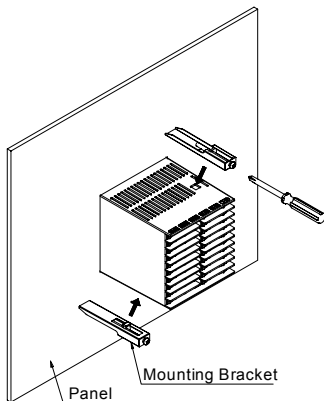

PD542-PD543

PD540-PD541

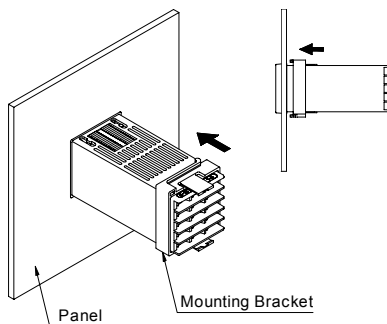
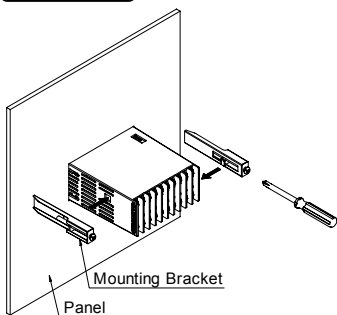
**Installation Steps**

1. Cut the mounting panel. (Refer to 7.1 Dimensions and Panel Cutouts)
2. Insert the controller through the front of the panel rear terminals first.
3. On applicable models, attach the right and left mounting bracket and secure it to the panel.
4. On 1/16 DIN controller models, slide the mounting bracket onto the back of the controller as shown, and slide it forward on the controller until the bracket locks in place, and the controller is secure.



Do not excessively tighten the mounting bracket screws. Excessive tightening may lead to controller or panel damage.

7.3 Power Cable Specification

Make power connections using 0.9 to 2.0 mm² or 16 AWG vinyl insulated wire. (Voltage rating of 300 VAC)

7.4 Terminal Specification

Use M3.5 screw-compatible crimp on terminals with insulating sleeve as shown below.



Note: Inches for reference only.

Use copper conductors only if the terminal is for connection to copper wire only.



Always turn off the source circuit breaker and check to ensure the power is off to the controller through the use of a tester prior to working on the wiring terminals.

- Never touch the terminals in the rear panel when power is supplied to the controller.
- Be sure to turn off the electric power before wiring any terminals.



Bind the wires connected to the controller terminals securely together in order to prevent electromagnetic interference.

7.5 Terminal Assignment, Connections, and Ratings

PD548-PD549

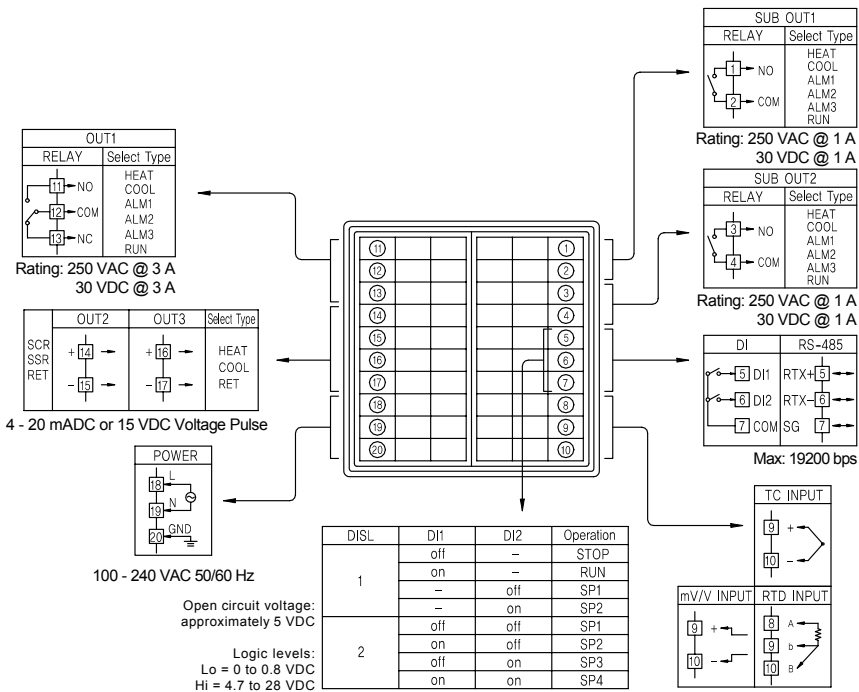

NO switches (external excitation not required) or open collector transistor

PD546-PD547

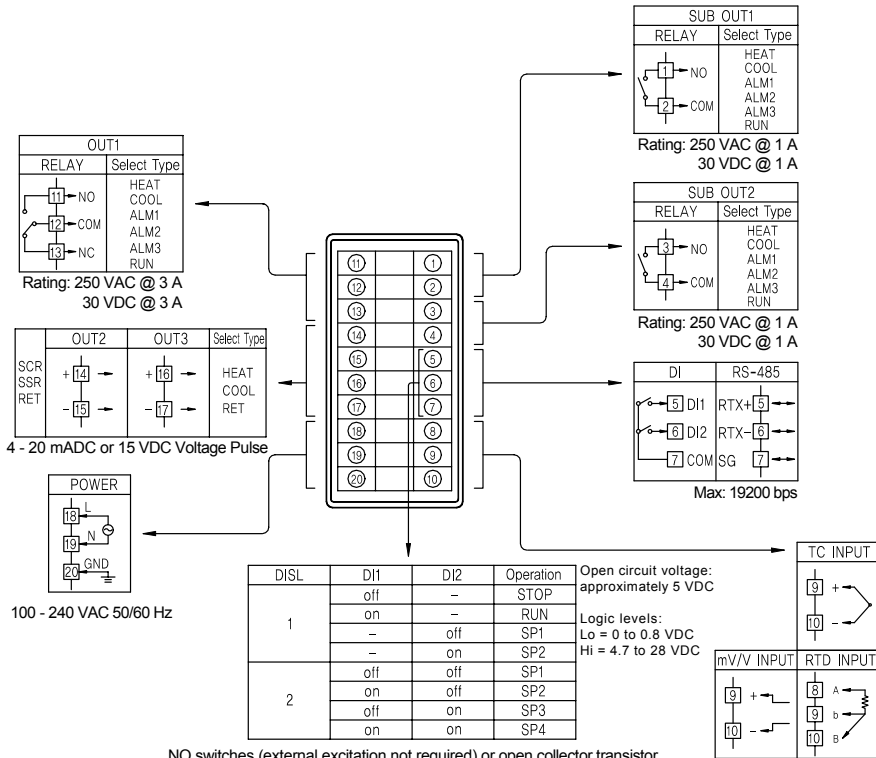

PD544-PD545

NO switches (external excitation not required) or open collector transistor

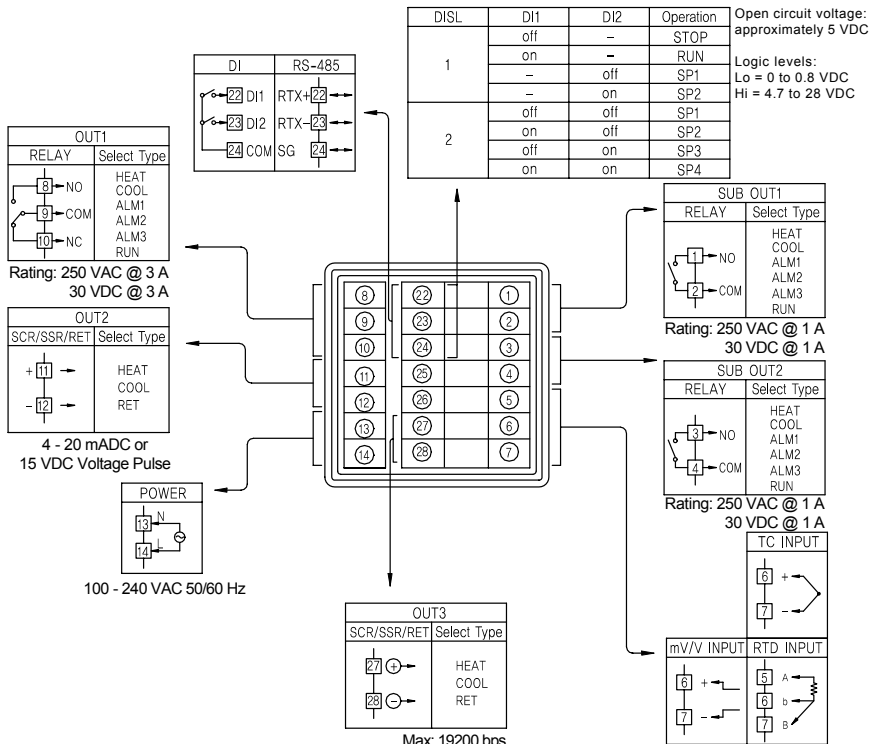

PD542-PD543

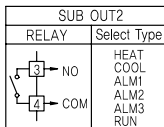

Rating: 250 VAC @ 1 A
30 VDC @ 1 A

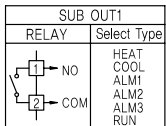

Rating: 250 VAC @ 1 A
30 VDC @ 1 A

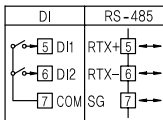

Max: 19200 bps

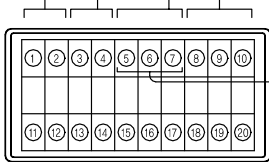
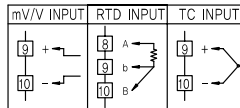

DISL	DI1	DI2	Operation
1	off	-	STOP
	on	-	RUN
	-	off	SP1
2	-	on	SP2
	off	off	SP1
	on	off	SP2
	off	on	SP3
	on	on	SP4

NO switches (external excitation not required)
or open collector transistor

Open circuit voltage:
approximately 5 VDC

Logic levels:
Lo = 0 to 0.8 VDC
Hi = 4.7 to 28 VDC

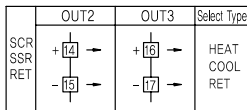

4 - 20 mA DC or
15 VDC Voltage Pulse

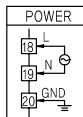

100 - 240 VAC 50/60 Hz

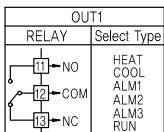

Rating: 250 VAC @ 3 A
30 VDC @ 3 A

PD540-PD541

NO switches (external excitation not required) or open collector transistor

DISL	DI1	DI2	Operation
1	off	-	STOP
	on	-	RUN
	-	off	SP1
2	-	on	SP2
	off	off	SP1
	on	off	SP2
	off	on	SP3
	on	on	SP4

Open circuit voltage:
approximately 5 VDC

Logic levels:
Lo = 0 to 0.8 VDC
Hi = 4.7 to 28 VDC

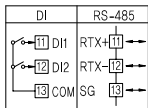

Max: 19200 bps

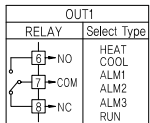

Rating: 250 VAC @ 3 A
30 VDC @ 3 A



100 - 240 VAC 50/60 Hz

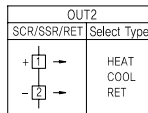
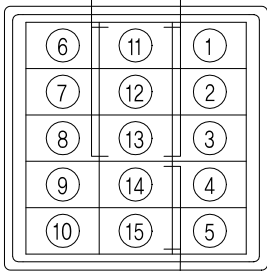

Rating: 250 VAC @ 1 A
30 VDC @ 1 A

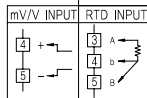

OUT3		SUB OUT	
SCR/SSR/RET	Select Type	RELAY	Select Type
+ [14]	HEAT	[14] NO	HEAT
- [15]	COOL	[15] COM	COOL
	RET		ALM1
			ALM2
			ALM3
			RUN

Rating: 250 VAC @ 1 A 4 - 20 mADC or
30 VDC @ 1 A 15 VDC Voltage Pulse

7.6 Grounding and Power Cable Connection

- Use a thick grounding cable of at least 2 mm² or 14 AWG and shorter than 20 m (approximately 22 ft) for class-3 grounding or better with a grounding resistance of less than 100 Ω.
- Be sure to ground from the grounding terminal to an independent grounding point. (1 point grounding)
- Use 0.9 to 2.0 mm² or 16 AWG vinyl insulated wire (Voltage rating 300VAC) or thicker for power cable connection.

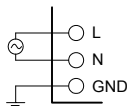

Be sure to connect L (Hot), N (neutral), and GND (ground) as indicated. Failure to wire the power and ground as indicated could result in damage to the controller.



To prevent electric shock, be sure to turn off power to the controller and the source circuit breaker before wiring.



- Be sure to connect to correct polarities. Connecting to a wrong polarity may cause damage or malfunction.
- Use shielded wires and ground the shielding to an independent grounding point.
- Keep the input signal and output wiring as far as possible away from the power and ground circuit.
- Use a wire with low conductive resistance and no three-wire resistance differential.

7.7 Signal Input Connection

(1) RTD Input

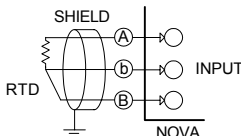

(2) DC Voltage Input

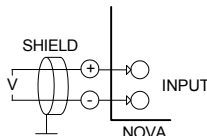

(3) DC Current Input

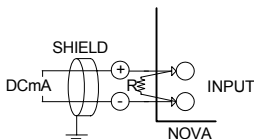

To accept a 4-20 mA signal, select 0.4 to 2.0 VDC input and connect a 100 Ω resistor across the input terminals as shown.

7.8 Analog Output Connection



To prevent electric shock, be sure to turn off power to the Nova Controller and the source circuit breaker before wiring.



- Be sure to connect to correct polarities. Connecting to a wrong polarity may cause a controller malfunction.
- Use shielded wires for the wiring and connect independently to ground (1 point grounding).

(1) Voltage Pulse Output (SSR) / Current Output (SCR)

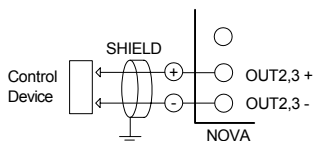

SCR : 4 to 20 mADC, 600 Ω maximum
 SSR : 12 VDC min, 600 Ω minimum



To prevent electric shock, be sure to turn off power to the Nova Controller and the source circuit breaker before wiring.

(2) Retransmitting Output (RET)

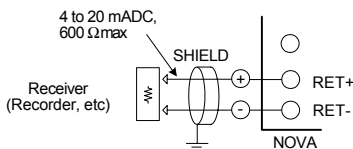

To prevent electric shock, be sure to turn off power to the Nova Controller and the source circuit breaker before wiring.

7.9 Relay Output Connection (RELAY)

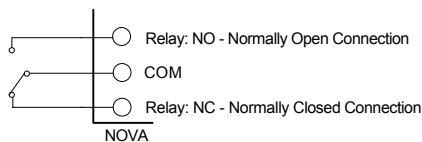

To prevent electric shock, be sure to turn off power to the Nova Controller and the source circuit breaker before wiring.

7.10 Digital Input Connection (DI)

- Use a no-voltage contact switch such as relay.
- The controller supplies the needed voltage (approx. 5 VDC) and current (approx. 1 mA) to trigger the input.
- When using an Open Collector (TR) as a trigger, use one with a 2 V or lower voltage rating when "on" and 100 μ A or less leakage current when it is OFF.

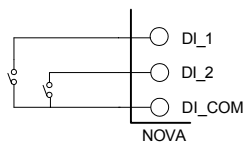

▲ Relay Contact Connection

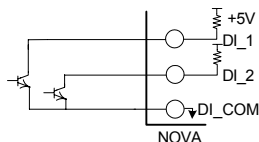

▲ Transistor Contact Connection



To prevent electric shock, be sure to turn off power to the Nova Controller and the source circuit breaker before wiring.

7.11 Use of an External Relay

Switching Inductive Loads

When using switching inductive loads, the use of RC networks (snubbers) for AC loads or diodes for DC loads is recommended to prevent disrupting the microprocessor's operation. The suppressors also prolong the life of the relay contacts. Suppression can be obtained with resistor-capacitor (RC) networks or diodes assembled by the user or purchased as complete assemblies.

For AC loads, choose R and C as follows:

R: 0.5 to 1 Ω for each volt across the contact

C: 0.5 to 1 μ F for each amp through closed contacts

Notes:

1. Use capacitors rated for 250 VAC.
2. RC networks may affect load release time of solenoid loads. Check to confirm proper operation.
3. RC networks are available from Precision Digital and should be applied to each relay contact switching an inductive load. Part number: PDX6901.



If the load inductance is over the controller specifications, the output may need a RC filter (snubber) or diode to properly handle frequent relay switching operations.

(1) DC External Relay

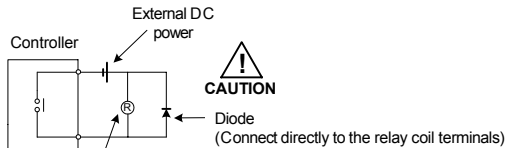

CAUTION (Verify relay coil ratings are less than the voltage and current ratings of the relay contacts of the controller)

(2) AC External Relay

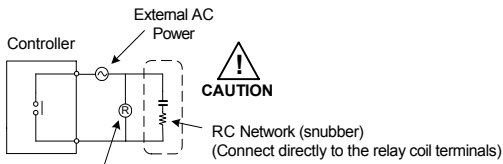

CAUTION (Verify relay coil ratings are less than the voltage and current ratings of the relay contacts of the controller)

7.12 Communication Wiring (RS-485)

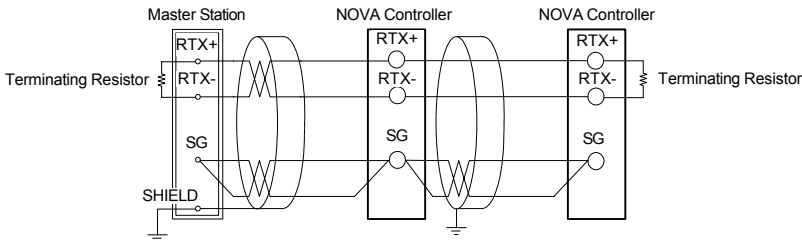

- Up to 31 slave controllers (Nova series controllers equipped with the RS-485 serial communication option) can be connected.
- Be sure to connect terminating resistors (220 Ω, 1/4 W) to slave and master controllers at communication channel ends as shown above.

CAUTION To prevent electric shock, be sure to turn off power to the Nova Controller and the source circuit breaker before wiring.

Table of D-Registers

NO.	PROCESS	FUNCTION	SET POINT	SIGNAL	ALARM	PID	IN/OUT
0	0	100	200	300	400	500	600
			SPSL				
1	NPV	R-S.STOP/RUN	SP1		ALT1	ARW	IN-T
2	NSP		SP2		ALT2	FUZZY	INT-U
3			SP3		ALT3		IN.RH
4			SP4				IN.RL
5	SPSL	A/M					IN.DP
6	MVOUT	H.OUT(MVOUT)			AL-1		IN.SH
7	HOUT	C.OUT(MVOUTc)			AL-2		IN.SL
8	COU				AL-3		IN.FL
9	PIDNO						BSL
10	NOWSTS						RSL
11			SPRH		A1DB	1.P	BSP1
12			SPRL		A2DB	1.I	BSP2
13					A3DB	1.D	BSP3
14	ALSTS		TMU			1.MR	
15						1.Pc	BS0
16			U.SLP		A1DY	1.Ic	BS1
17			D.SLP		A2DY	1.Dc	BS2
18					A3DY	1.DB	BS3
19	ERROR					RP1	BS4
20	PROC_TIME						
21		AT			AL1.H	2.P	OUT1
22		AT-G			AL2.H	2.I	OUT2
23					AL3.H	2.D	OUT3
24						2.MR	
25						2.Pc	SUB1
26					AL1.L	2.Ic	SUB2
27					AL2.L	2.Dc	
28					AL3.L	2.DB	
29						RP2	
30							
31		S-TM				3.P	HEAT2
32		P-TM				3.I	COOL2
33						3.D	HEAT3
34		ONOF				3.MR	COOL3
35		US1				3.Pc	
37		US2				3.Ic	
36		LOCK				3.Dc	O.ACT
38		DI.SL				3.DB	CT
39		DSP.H				RHY	CTc
40		DSP.L					
41						4.P	OH
42						4.I	OL
43						4.D	

NO.	PROCESS	FUNCTION	SET POINT	SIGNAL	ALARM	PID	IN/OUT
	0	100	200	300	400	500	600
44						4.MR	HYS
45						4.Pc	
46						4.lc	PO
47						4.Dc	POc
48						4.DB	HYS.H
49						RDV	HYS.L
50							
51							RET
52							RETH
53	U						RETL
54	s						
55	e						
56	r						
57							
58	A						
59	r						
60	e						
61	a						COM.P
62							BAUD
63							PRTY
64							SBIT
65							DLEN
66							ADDR
67							RP.TM
68							
69							
70							
71							
72							
73							
74							
75							
76							
77							
78							
79							
80							
81							
82							
83							
84							
85							
86							
87							

NO.	PROCESS	FUNCTION	SET POINT	SIGNAL	ALARM	PID	IN/OUT
88	0	100	200	300	400	500	600
89							
90							
91							
92							
93							
94							
95							
96							
97							
98							
99							



NOTE

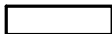

Read Only Location

Notes



Warranty and Return Information

Precision Digital warrants this product to be free from material defects and workmanship under normal use and service for three years.

Please contact Precision Digital Technical Support at (800) 610-5239 or e-mail at support@predig.com prior to any product return. When Technical Support determines a product should be returned, a Return Material Authorization (RMA) # which must be included on the return shipping label. Please also include the reason for return, date of purchase, contact name, and how to contact. Products returned for reasons other than repair may be subject to a restocking fee. Any returns under a warranty claim should be returned freight prepaid. Upon warranty confirmation Precision Digital will repair or replace and return the unit at no charge via UPS Ground. Other shipping is available upon request and at customer expense. All product returns should be shipped to:

Return Authorization # _____
Precision Digital, 19 Strathmore Road, Natick, MA 01760 USA
Attention: Technical Support

Precision Digital Technical Support is trained and eager to serve you. We have found most start-up problems to be the result of incorrect signal connections and/or programming. Most often Precision Digital Technical Support can quickly correct these issues over the telephone.

How to Contact Precision Digital

- For Technical Support
Call: (800) 610-5239 or (508) 655-7300
Fax: (508) 655-8990
Email: support@predig.com
- For Sales Support or to place an order please
Call: (800) 343-1001 or (508) 655-7300
Fax: (508) 655-8990
Email: sales@predig.com
- For the latest version of this manual, please visit
www.predig.com

