

LEVEL MONITOR

WITH ANALOG AND HIGH / LOW ALARM
OUTPUTS.



Features

- Displays level and percentage filled.
- 4 alarm values can be entered: low-low, low, high and high-high level alarm.
- Large 17mm (0.67") digits.
- Selectable on-screen engineering units; volumetric or mass.
- Operational temperature -30°C up to +80°C (-22°F up to 178°F).
- Very compact design for panel mount, wall mount or field mount applications.
- Rugged aluminum field mount enclosure IP67/NEMA4X.
- Intrinsically safe
⊕ II 1GD EEx ia IIB/IIC T4 T100°C.
- Explosion/flame proof ⊕ II 2G EEx d IIB T5.
- Alarm and analog signal outputs.
- Full Modbus communication RS232/485/TTL.
- Loop or battery powered, 8 - 24V AC/DC or 115 - 230V AC power supply.
- Sensor supply 3.2 - 8.2 - 12 - 24V DC.

Signal output

- Up to 4 free configurable alarm outputs.
- (0)4 - 20mA / 0 - 10V DC according to the level.

Signal input

Level

- (0)4 - 20mA.
- 0 - 10V DC.

Applications

- Level measurement and continuous level monitoring is important. Also re-transmission of the level or serial communication is required.
Alternative basic model: F070 - F073 - F077 and F170 or more sophisticated model F173.



General information

Introduction

The F170 is a versatile level indicator with continuous level monitoring feature. It offers the facility to set two low level and two high level alarm values. If desired, an ignore function can be set up to allow for an incorrect level for a certain period of time. Up to four outputs are available to transmit the alarm condition.

A wide selection of options further enhance this models capabilities, including intrinsic safety and full Modbus communication.

Display

The display has large 17mm (0.67") and 8mm (0.31") digits which can be set to show level, percentage and alarm values.

The alarm values can be password protected. On-screen engineering units are easily configured from a comprehensive selection.

Configuration

All configuration settings are accessed via a simple operator menu which can be pass-code protected. Each setting is clearly indicated with an alphanumerical description, therefore avoiding confusing abbreviations. All settings are safely stored in EEPROM memory in the event of sudden power failure.

Analog output signal

The actual level is re-transmitted with the (0)4 - 20mA or 0 - 10V DC output signal. The output signal is updated ten times per second with a filter function being available to smoothen out the signal if desired. The output value is user defined in relation to the level, e.g. 4mA equals to 5m³ and 20mA equals to 20.000 m³. The output signal can be passive, active or isolated where the passive output type will loop power the F170 as well.

Alarm outputs

Up to four configurable outputs are available to transmit the alarm condition. You can have e.g. two the same low alarm outputs, one high alarm output and one "all alarms" output. Type OS offers four mechanic relay outputs. However, only two outputs are available in Intrinsically Safe applications. Three outputs are available in all other configurations. The output

signals can be a passive NPN, active PNP or an isolated electro-mechanical relay.

Signal input

The F170 does accept (0)4 - 20mA and 0 - 10V input signals from any type of level measurement device. Also a 4 - 20mA input loop powered model is available.

Communication

All process data and settings can be read and modified manually or through the Modbus communication link (RS232 / RS485).

Full Modbus functionality remains available for the Intrinsically Safe version (TTL).

Hazardous areas

For hazardous area applications, this model has been ATEX certified intrinsically safe Ex II 1GD EEx ia IIB / IIC T4 T100°C with an allowed operational temperature of -30°C to +70°C (-22°F to +158°F). A flame proof enclosure is also available with the rating Ex II 2G EEx d IIB T5.

Enclosures

Various types of enclosures can be selected, all ATEX approved. As standard the F170 is supplied in an ABS panel mount enclosure, which can be converted to an IP67 / NEMA 4X ABS field mount enclosure by the addition of a back case. Most popular is our rugged aluminum field mount enclosure with IP67 / NEMA 4X rating. Both European or U.S. cable gland entry threads are available.

Overview application F170

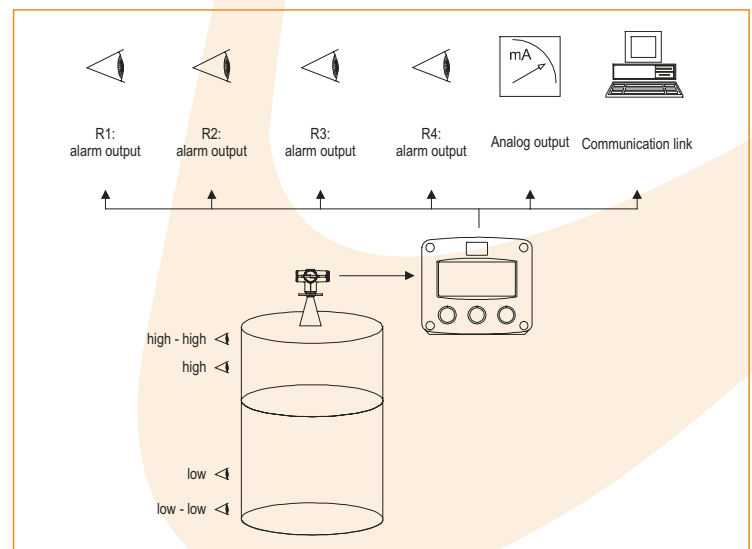

Typical wiring diagram F170-A-AA-CB-OA-PD

Typical wiring diagram F170-A-AP-CH-OT

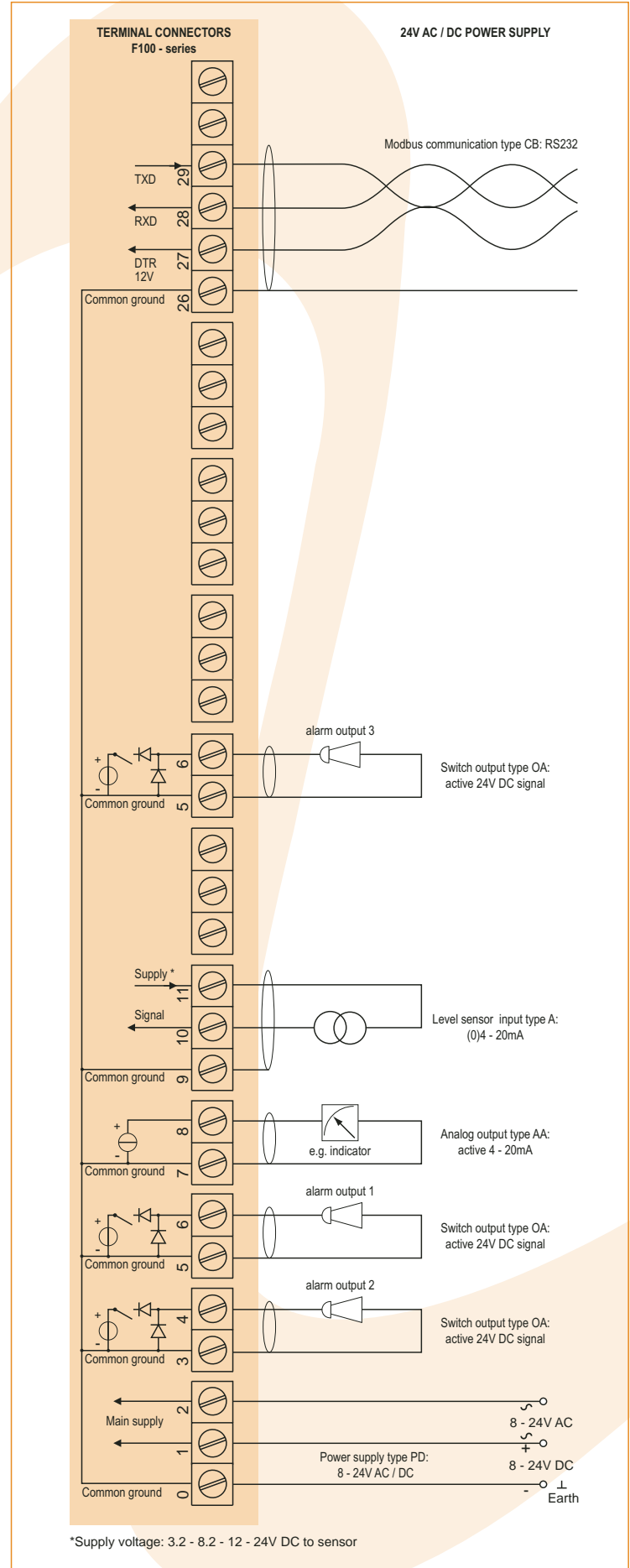
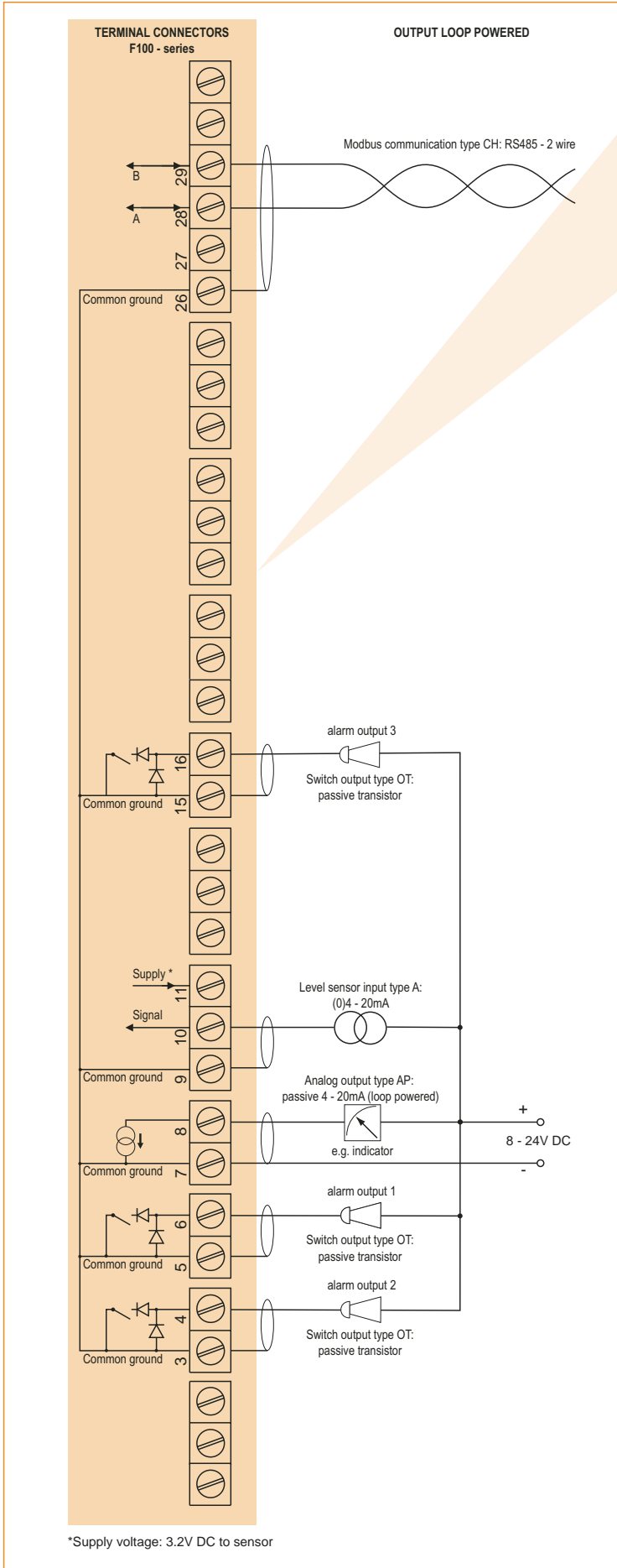

Typical wiring diagram F170-P-AP-CB-OS-PD

Typical wiring diagram F170-A-AI-CI-OR-PM

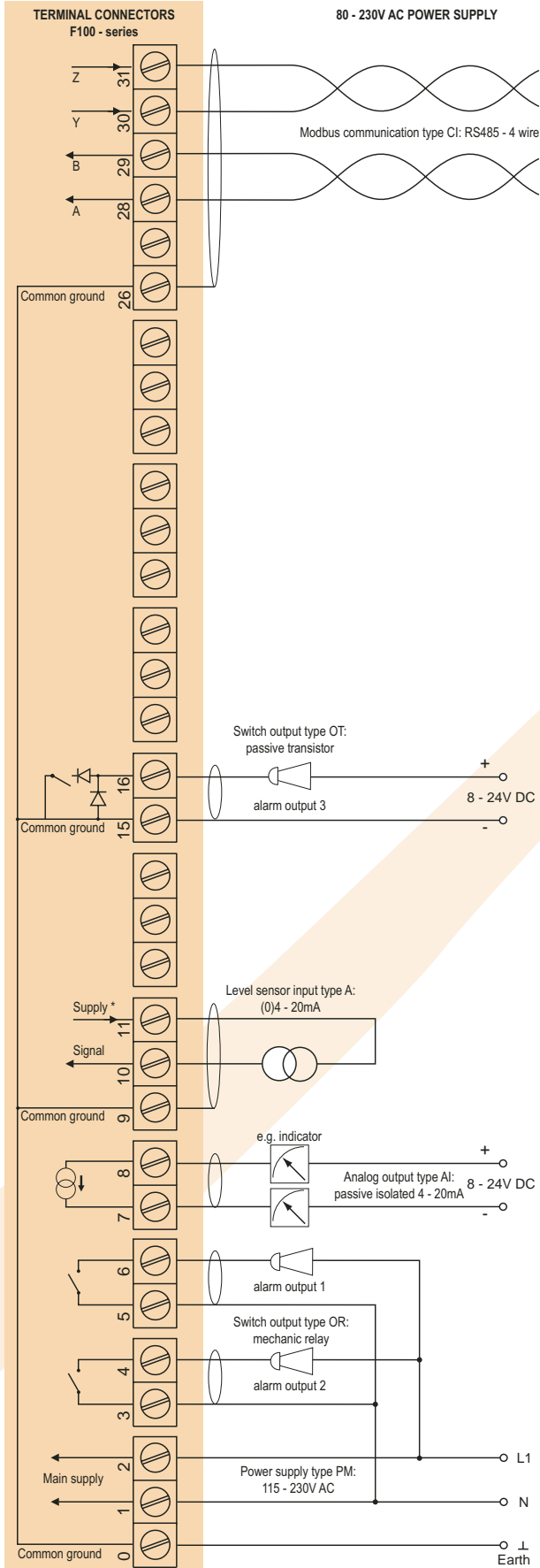

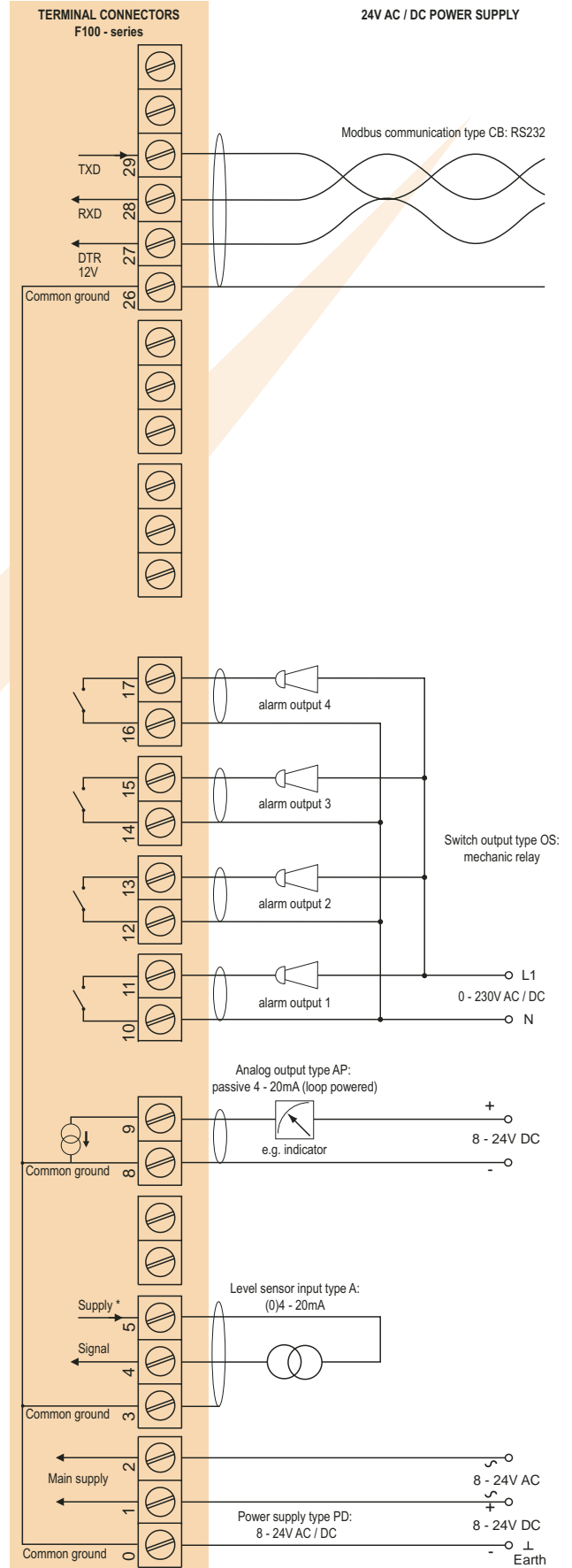

*Supply voltage: 3.2 - 8.2 - 12 - 24V DC to sensor



*Supply voltage: 3.2 - 8.2 - 12 - 24V DC to sensor

Hazardous area applications

The F170-XI has been ATEX approved by KEMA for use in intrinsically safe applications. It is approved according to  II 1GD EEx ia IIB/IIC T4 T100°C for gas and dust applications with an operational temperature range of -30°C to +70°C (-22°F to +158°F). Besides the I.S. power supplies for the two alarm outputs, it is allowed to connect up to three I.S. power supplies in IIB applications or one in IIC applications. Full functionality of the F170 remains available, including two alarm outputs and 4 - 20mA output and Modbus communication (type CT). Power supply type PD-XI offers a sensor supply according to the connected power supply voltage at terminal 1. A flame proof enclosure with rating  II 2G EEx d IIB T5 is available as well. Please contact your supplier for further details.

Certificate of conformity KEMA 03ATEX1074 X



Configuration example IIB

F170-A-CT-OT-PL-XI - input loop powered unit

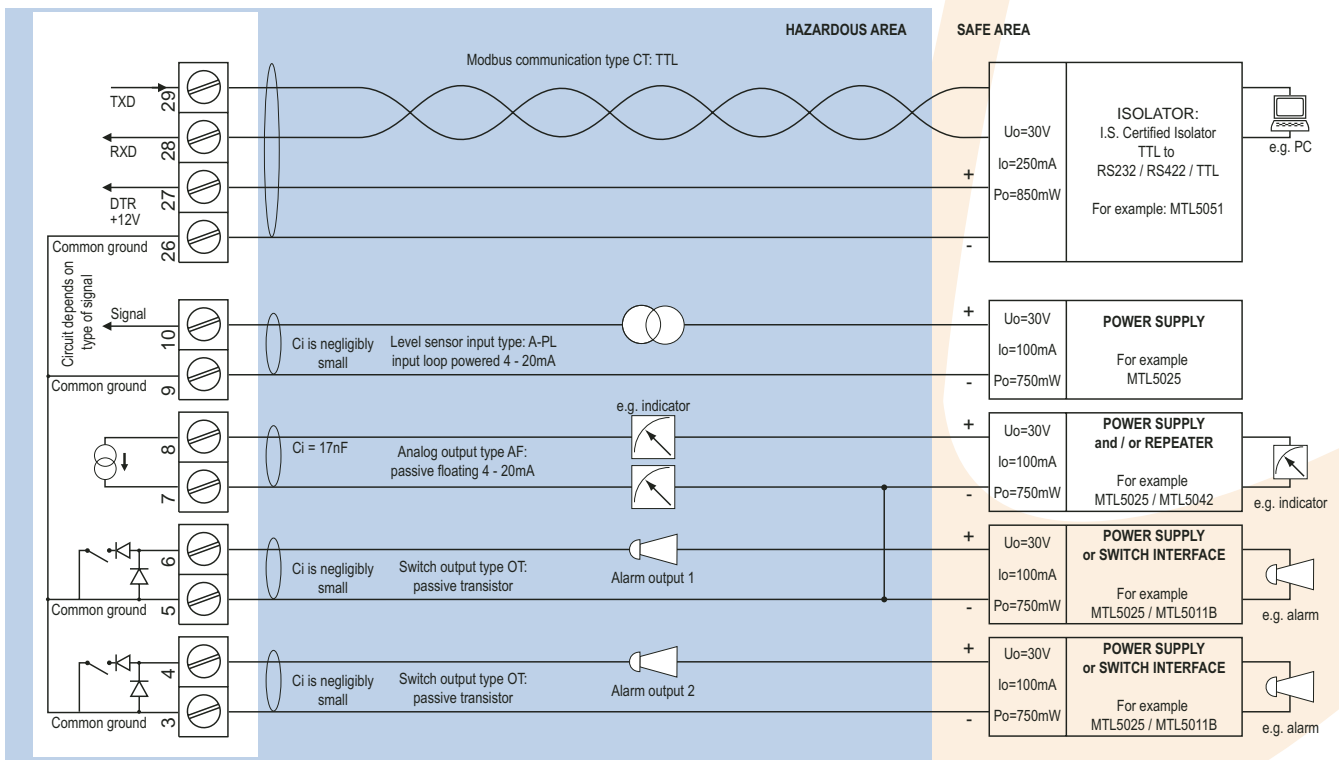

Configuration example IIB - F170-A-AP-CT-OT-(PD)-XI - output loop powered

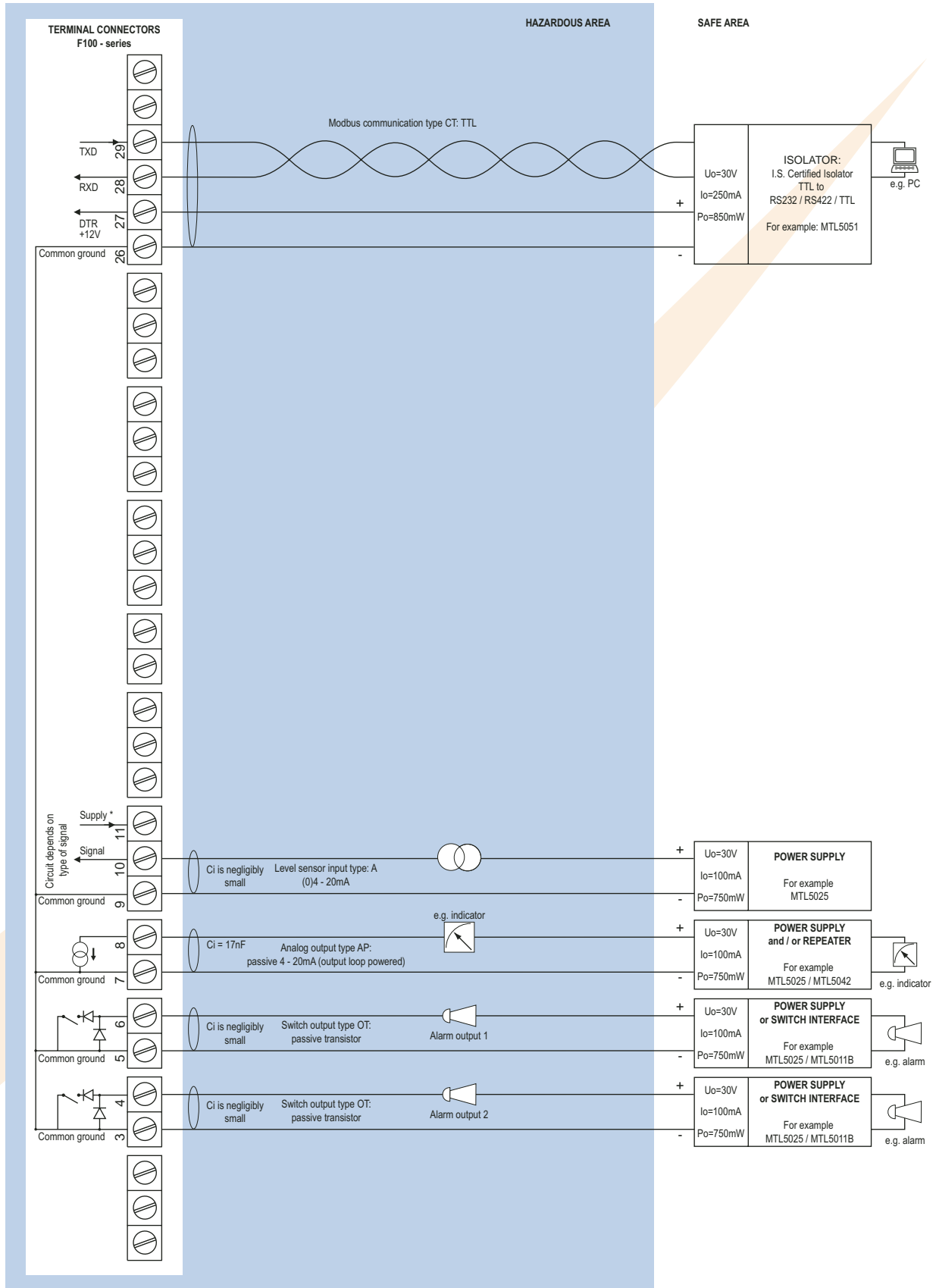

Configuration example IIB and IIC - F170-A-AP-(CT)-OT-PD-XI - power supply 16 - 30V DC

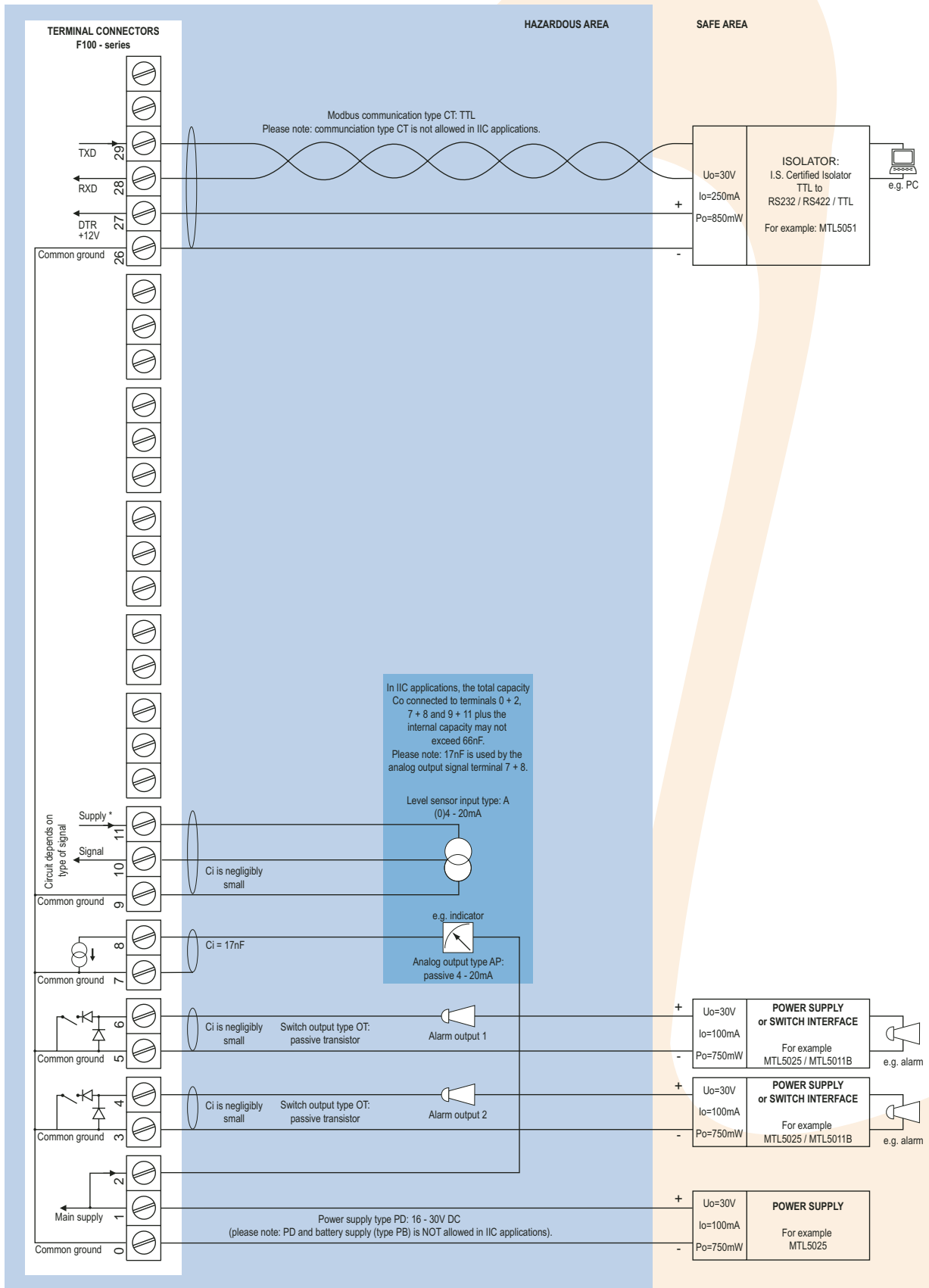

* Note power supply type PD: the supply voltage to the sensor is as connected to terminal 1 (internally linked).

Configuration example IIB - F170-A-AF-CT-OT-(PB)-(PD)-(PL)-XI

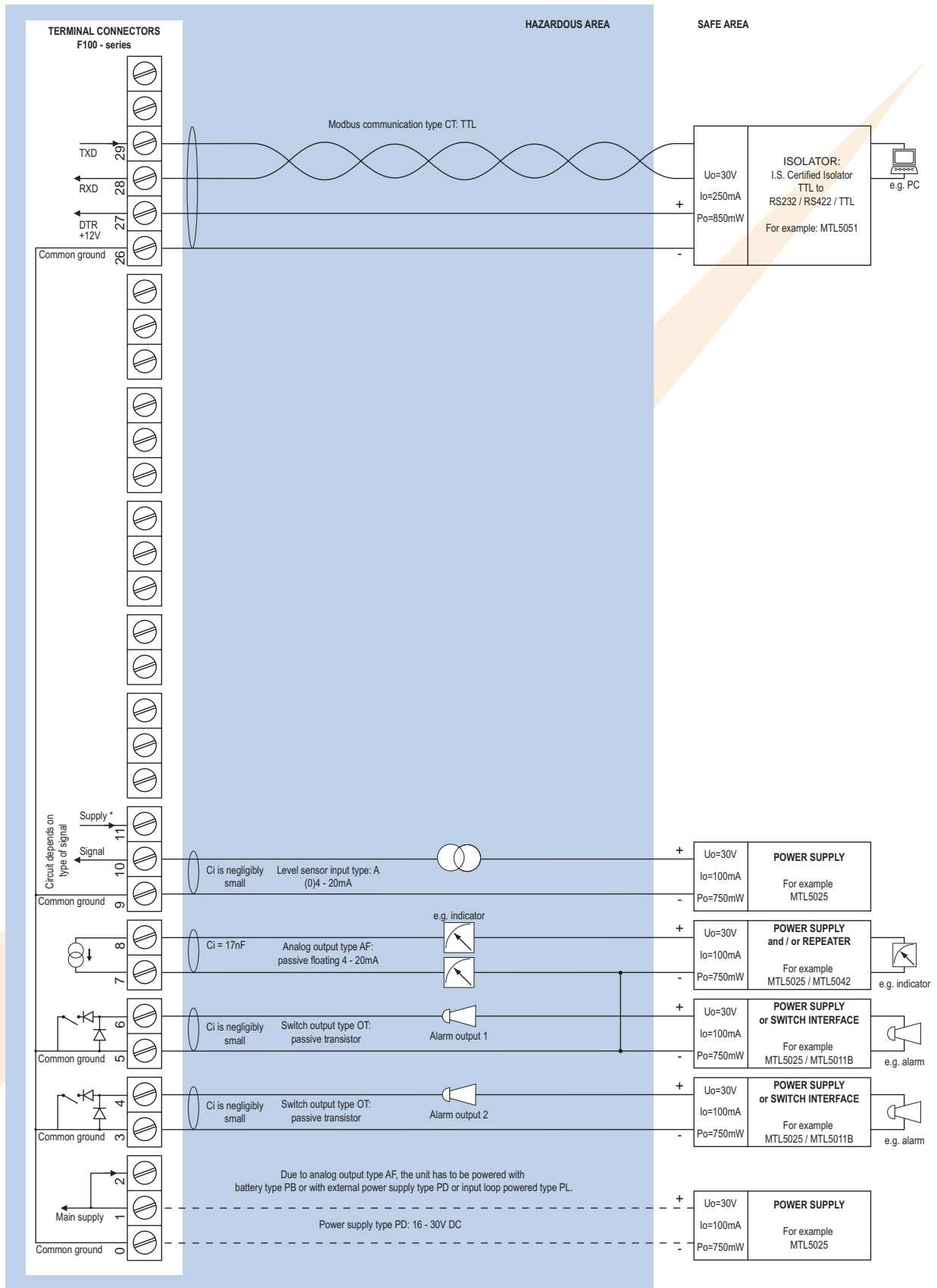

Technical specification

General

Display	
Type	High intensity reflective numeric and alphanumeric LCD, UV-resistant.
Dimensions	90 x 40mm (3.5" x 1.6").
Digits	Seven 17mm (0.67") and eleven 8mm (0.31") digits. Various symbols and measuring units.
Refresh rate	User definable: 8 times/sec. - 30 secs.
Option ZB	LED-backlight - available appr. Jan. 2005.

Casing	
Window	Polycarbonate window.
Sealing	EPDM and PE.
Control keys	Three industrial micro-switch keys. UV-resistant polyester keypad.
Type HA	Die-cast aluminum field mount enclosure IP67 / NEMA 4X with 2-component UV-resistant coating.
Dimensions	130 x 114 x 58mm (5.1" x 4.5" x 2.28") - W x H x D.
Cable Entry	2 x PG9 and 1 x M20 tapped hole in the centre.
Weight	950 gr.
Type HB	Die-cast aluminum panel mount enclosure IP65 / NEMA 4 with 2-component UV-resistant coating.
Dimensions	130 x 114 x 50mm (5.1" x 4.5" x 1.97") - W x H x D.
Panel cut-out	115 x 96mm (4.53" x 3.78") L x H.
Weight	525 gr.
Type HC	ABS panel mount enclosure IP65 / NEMA 4, UV-resistant and flame retardant.
Dimensions	130 x 114 x 48mm (5.1" x 4.5" x 1.89") - W x H x D.
Panel cut-out	115 x 96mm (4.53" x 3.78") L x H.
Weight	300 gr.
Type HD	ABS wall mount enclosure IP67 / NEMA 4X, UV-resistant and flame retardant.
Dimensions	130 x 114 x 71mm (5.1" x 4.5" x 2.8") - W x H x D.
Cable Entry	None, user defined.
Weight	400 gr.
Type HU	Die-cast aluminum field mount enclosure IP67 / NEMA 4X with 2-component UV-resistant coating.
Dimensions	5.1" x 4.5" x 2.28" - W x H x D.
Cable Entry	3 x 1/2" NPT tapped hole.
Weight	950 gr.



Operating temperature	
Operational	-30°C to +80°C (-22°F to +178°F).

Power requirements	
Type PB	Long life Lithium battery - life-time depends upon settings and configuration - up to 5 years.
Type PD	8 - 24V AC/DC ± 10%.
Type PD-XI	16 - 30V DC (Intrinsically Safe).
Type PF	24V AC/DC ± 10%.
Type PL	Input loop powered from sensor signal 4 - 20mA (type "A") - requires types AI or AF and OT.
Type PM	115 - 230V AC ± 10%.
Type PX	8 - 28V DC output loop powered unit with analog output signal type AP (or 8 - 24 V AC/DC if type AP will not be used).

Sensor excitation	
Type PB / PX	3.2V DC.
Type PD	3.2 - 8.2 - 12 and 24V DC - max. 50mA@24V DC.
Type PD-XI	The sensor supply volage is according to power supply as connected to terminal 1 (internally linked).
Type PF / PM	3.2 - 8.2 - 12 and 24V DC - max. 200mA@24V DC.

Terminal connections	
Type	Removable plug-in terminal strip. Wire max. 1.5mm ² and 2.5mm ² .

Data protection	
Type	EEPROM backup of all settings. Data retention at least 10 years.
Pass-code	Configuration settings can be pass-code protected.

Hazardous area	
Intrinsically safe	ATEX approval ref:  II 1GD EEx ia IIB/IIC T4 T100°C.
Type XI	CSA/FM pending. Maximum ambient +70°C (158°F).
Explosion proof	ATEX approval ref:  II 2G EEx d IIB T5.
Type XD/XF	Dimensions of enclosure: 218 x 418 x 210mm (8.58" x 16.45" x 8.38") L x H x D.
Weight	16 Kg.

Environment	
Electromagnetic compatibility	Compliant ref: EN 61326 (1997), EN 61010-1 (1993).

Signal inputs

Level sensor	
Type A	(0)4 - 20mA. Analog input signal can be scaled to any desired range within 0 - 20mA.
Type U	0 - 10V DC. Analog input signal can be scaled to any desired range within 0 - 10V DC.
Accuracy	14 bit. Error < 0.05%. Low level cut-off programmable.
Span	0.000010 - 9,999,999 with variable decimal position.
Offset	-999,999 - +999,999 units.
Update time	Four times per second.
Voltage drop	Type A: 2.5V@20mA.
Load impedance	Type U: 3kΩ.
Relationship	Linear calculation.
Note	For signal type A and U: external power to sensor is required; e.g. type PD.

Signal outputs

Analog output

Function	Transmitting level.
Accuracy	10 bit. Error < 0.05%. Analog output signal can be scaled to any desired range.
Update time	Ten times per second.
Type AA	Active 4 - 20mA output (requires OA + PD, PF or PM).
Type AB	Active 0 - 20mA output (requires OA + PD, PF or PM).
Type AF	Passive floating 4 - 20mA output for Intrinsically Safe applications (requires PB, PL or PD).
Type AI	Passive galvanically isolated 4 - 20mA output - also available for battery powered models (requires PB, PD, PF, PL or PM).
Type AP	passive 4 - 20mA output - not isolated. Unit will be loop powered.
Type AU	Active 0 - 10V DC output (requires OA + PD, PF or PM).

Alarm outputs

Function	User defined: low, low-low, high, high-high or all alarms output.
Type OA	Three active 24V DC transistor outputs (PNP); max. 50mA per output (requires AA + PD, PF or PM).
Type OR	Two electro-mechanical relay outputs isolated (N.O.) - max. switch power 230V AC - 0.5A (requires PF or PM) and one transistor output OT or OA (OA in combination with AA only).
Type OS	Four electro-mechanical relay outputs - isolated; max. switch power 230V AC - 0.5A per relay (requires AP and PD).
Type OT	Three passive transistor outputs (NPN) - not isolated.
Load	Max. 50V DC - 300mA per output.
Note	Intrinsically Safe applications: only two transistor outputs type OT available.

Communication option

Function	Reading display information, reading / writing all configuration settings.
Type CB	RS232
Type CH	RS485 2-wire
Type CI	RS485 4-wire
Type CT	TTL Intrinsically Safe.
Protocol	Modbus RTU.
Speed	1200 - 2400 - 4800 - 9600 baud.
Addressing	Maximum 255 addresses.

Operational

Operator functions

Displayed functions	<ul style="list-style-type: none"> • Level and percentage or height. • Low-low alarm value. • Low alarm value. • High alarm value. • High-high alarm value. • Alarm values can be set (or only displayed).
---------------------	--

Level

Digits	7 digits.
Units	mL, L, m ³ , Gallons, KG, Ton, lb, bl, cf, RND, ft ³ , scf, Nm ³ , NL, ical - no units.
Decimals	0 - 1 - 2 or 3.
Offset	User defined quantity.

Percentage

Digits	4 digits.
Decimals	1.

Alarm values

Function	Four user defined alarm values to monitor the level.
Digits	7 digits.
Units	According to the settings for level.
Decimals	According to the settings for level.
Type of alarm	Low, high, low-low or high-high level alarm. Includes alarm delay time and configurable alarm outputs.
Protection	The alarm values can be pass-code protected.

Display example - 90 x 40mm (3.5" x 1.6")



Ordering information

Example (standard configuration)

F170-A-AP-CX-HC-OT-PX-XX-ZX.

Explanation standard configuration:

A: level input signal: analog; AP: passive 4 - 20mA analog output; CX: no communication; HC: ABS panel mount enclosure; OT: three passive transistor outputs; PX: the unit is powered by the analog output loop, type AP: 8 - 28V DC (or AC); XX: Safe area; ZX: no options.

Ordering information:	F170	-	-A	-C	-H	-O	-P	-X	-Z
Level input signal									
A	⊗								
U	⊗								
Analog output signal									
AA									
AB									
AF	⊗								
AI									
AP	⊗								
AU									
Communication									
CB									
CH									
CI									
CT	⊗								
CX	⊗								
Enclosure									
HA	⊗								
HB	⊗								
HC	⊗								
HD	⊗								
HU	⊗								
Outputs									
OA									
OR									
OS									
OT	⊗								
Power supply									
PB	⊗								
PD	⊗								
PF									
PL	⊗								
PM									
PX	⊗								
Hazardous area									
XI	⊗								
XD	⊗								
XF	⊗								
XX									
Other options									
ZB	⊗								
ZX	⊗								

The bold marked text contains the standard configuration.

⊗ Available Intrinsically Safe.

Specifications are subject to change without notice.

FLUIDWELL bv
P.O. Box 6
5460 AA - Veghel - The Netherlands
Tel.: +31 (0)413 343786
Fax.: +31 (0)413 363443
sales@fluidwell.com
Internet: www.fluidwell.com

